

5315A/B 100 MHz Universal Counter

OPERATING AND SERVICE MANUAL

Serial Prefix: 2120A

This manual applies to instruments with Serial Prefix 2120A unless accompanied by a Manual Change Sheet.

OLDER INSTRUMENTS

For Serial Prefixes 2032A and below, refer to Section VII for manual backdating.

First Edition — September 1978

Second Edition — July 1979

Third Edition — August 1981

©Copyright 1981

by

HEWLETT-PACKARD COMPANY

5301 Stevens Creek Boulevard

Santa Clara, California 95050

MANUAL PART NUMBER 05315-90021
Microfiche Part Number 05315-90022



TABLE OF CONTENTS

Section	Title	Page
I	GENERAL INFORMATION	1-1
	1-1. Introduction	1-1
	1-5. Description	1-1
	1-9. Specifications	1-1
	1-11. Options	1-5
	1-13. Safety Considerations	1-5
	1-15. Instrument Identification	1-5
	1-17. Accessories	1-6
	1-19. Recommended Test Equipment	1-6
II	INSTALLATION	2-1
	2-1. Introduction	2-1
	2-3. Unpacking and Inspection	2-1
	2-5. Preparation for Use	2-1
	2-6. Power Requirements	2-1
	2-8. Line Voltage Selection	2-1
	2-16. Power Cable	2-3
	2-18. Operating Environment	2-3
	2-22. Storage and Shipment	2-4
	2-23. Environment	2-4
	2-26. Packaging	2-4
	2-29. Field Installation of Options	2-4
	2-31. Part Numbers for Ordering Option Kits	2-5
	2-33. Installation of TCXO Option 001	2-6
	2-35. Installation of Battery Pack and Charger Option 002	2-6
	2-37. Installation of C Channel Option 003	2-7
	2-41. Installation of Oven Oscillator Option 004 (5315A)	2-9
	2-43. Installation of Oven Oscillator Option 004 (5315B)	2-10
III	OPERATION	3-1
	3-1. Introduction	3-1
	3-3. Operating Characteristics	3-1
	3-6. Modes of Operation	3-1
	3-8. FREQ A	3-1
	3-10. PER A	3-2
	3-12. T.I. A→B	3-2
	3-14. T.I. AVG A→B	3-2
	3-17. T.I. DELAY	3-3
	3-19. RATIO A/B	3-3
	3-21. A BY B (Gated Totalize)	3-4
	3-23. A ARMED BY B	3-4
	3-27. FREQ C (Option 003)	3-6
	3-29. TOT STOP/START	3-6
	3-31. CHECK	3-6
	3-33. Display Check	3-7
	3-35. Front and Rear Panel Features and Controls	3-7
	3-37. Function Selection Controls	3-7
	3-42. Signal Conditioning Controls	3-8

TABLE OF CONTENTS (Continued)

Section	Title	Page
	3-45. Trigger Level/Sensitivity Controls	3-8
	3-47. Display	3-14
	3-49. Operating Instructions	3-14
	3-51. Operator's Check	3-14
	3-52. Power-Up Self Check	3-15
	3-55. Error Messages	3-15
	3-58. Measurement Procedures	3-17
	3-60. Frequency, Period, and Ratio Measurements	3-17
	3-61. Time Interval Measurements	3-18
	3-62. Options	3-18
	3-64. Temperature Compensated Time Base OPTION 001	3-18
	3-66. Battery and Charger OPTION 002	3-18
	3-68. C Channel OPTION 003	3-18
	3-70. Oven Contained Time Base OPTION 004	3-18
	3-73. Offset/Normalizer OPTION 006	3-19
	3-75. Operator's Maintenance	3-19
	3-78. Power/Warm Up	3-20
IV	PERFORMANCE TESTS	4-1
	4-1. Introduction	4-1
	4-4. Operational Verification	4-1
	4-6. Performance Tests	4-1
	4-8. Equipment Required	4-1
	4-10. Test Record	4-1
V	ADJUSTMENTS	5-1
	5-1. Introduction	5-1
	5-4. Equipment Required	5-1
	5-6. Factory Selected Components	5-1
	5-8. Adjustment Locations	5-1
	5-10. Adjustment Procedures	5-2
	5-11. 5315A Voltage Selector	5-2
	5-13. Power Supply Adjustments	5-4
	5-15. Input Offset Adjustments	5-4
	5-17. Standard Oscillator Adjustment	5-6
	5-19. Option 001 Oscillator Adjustment (TCXO)	5-6
	5-23. Option 004 Oven Contained Oscillator Adjustment (5315A/B)	5-9
	5-25. Option 002 Battery Charger Adjustment	5-9
	5-27. Option 003 1 GHz Channel C Adjustment	5-12
VI	REPLACEABLE PARTS	6-1
	6-1. Introduction	6-1
	6-3. Abbreviations	6-1
	6-5. Replaceable Parts	6-1
	6-9. Ordering Information	6-1
	6-12. Direct Mail Order System	6-3
	6-15. Special Parts Replacement Considerations	6-3

TABLE OF CONTENTS (Continued)

Section	Title	Page
VII	MANUAL CHANGES	7-1
	7-1. Introduction	7-1
	7-3. Manual Changes	7-1
VIII	SERVICE	8-1
	8-1. Introduction	8-1
	8-3. Theory of Operation	8-1
	8-5. Troubleshooting	8-1
	8-8. Recommended Test Equipment	8-1
	8-10. Schematic Diagram Notes	8-1
	8-12. Reference Designations	8-1
	8-14. Identification Markings on Printed Circuit Boards	8-3
	8-17. Safety Considerations	8-3
	8-21. Safety Symbols	8-4
	8-23. Service Aids	8-4
	8-24. Pozidriv Screwdrivers	8-4
	8-26. Service Aids on Printed Circuit Boards	8-4
	8-28. Assembly Identification	8-5
	8-30. Theory of Operation	8-5
	8-31. Introduction	8-5
	8-33. Overall Block Theory	8-7
	8-38. Assembly Circuit Theory	8-7
	8-40. A1 Motherboard	8-7
	8-52. A2 Display Assembly	8-9
	8-54. A3 Input Assembly	8-9
	8-58. A4 Amplifier Assembly	8-9
	8-62. A8 Power Module	8-10
	8-64. A13 Standard Oscillator	8-10
	8-66. Options Theory (Options 001, 002, 003 and 004)	8-10
	8-67. A6 Battery Charger Assembly Option 002	8-10
	8-75. Battery Operation with Oven Oscillator (Option 004)	8-12
	8-77. Battery Annunciators	8-13
	8-85. A7 TCXO Option 001	8-14
	8-87. A9 C Channel Option 003	8-14
	8-95. A14 and A15 Oven Contained Reference Oscillator Options	8-16
	8-101. Troubleshooting Test Procedures	8-16
	8-104. Test Procedure 1, Power Supply	8-16
	8-106. Test Procedure 2, Microcomputer, Display, and Data Bus ...	8-17
	8-108. Test Procedure 3, Reference Oscillator	8-18
	8-111. Test Procedure 4, Input Amplifiers	8-18
	8-113. Test Procedure 5, Front Panel Switches	8-20
	8-115. Test Procedure 6, Multiple Register Counter (MRC)	8-20
	8-117. Test Procedure 7, Battery Pack (Option 002)	8-20
	8-123. Test Procedure 8, C Channel (Option 003)	8-24

LIST OF TABLES

Table	Title	Page
1-1.	5315A/B Specifications	1-2
1-2.	Accessories Supplied	1-6
1-3.	Accessories Available	1-6
1-4.	Recommended Test Equipment	1-6
2-1.	Option Parts for Field Installation	2-5
3-1.	Display Check	3-7
4-1.	Operational Verification	4-2
4-2.	In-Cabinet Performance Test	4-5
5-1.	Adjustments	5-2
5-2.	Factory Selected Components	5-2
6-1.	Reference Designations and Abbreviations	6-2
6-2.	Replaceable Parts	6-5
6-3.	Option 001 Replaceable Parts	6-15
6-4.	Option 002 Replaceable Parts	6-16
6-5.	Option 003 Replaceable Parts	6-18
6-6.	5315A Option 004 Replaceable Parts	6-20
6-7.	5315B Option 004 Replaceable Parts	6-21
6-8.	Manufacturers Code List	6-22
7-1.	Manual Changes by Series Number	7-1
7-2.	A6 Adjustments (Series 1812 through 2032)	7-5
7-3.	5315A-A1 Assembly Replaceable Parts	7-7
7-4.	5315B-A1 Assembly Replaceable Parts	7-9
7-5.	5315A-A6 Assembly Replaceable Parts	7-11
8-1.	Assembly Identification	8-5
8-2.	Battery-Pack Operation	8-10
8-3.	Battery-Pack Troubleshooting	8-21
8-4.	Battery State-of-Charge	8-23

LIST OF FIGURES

Figure		Page
1-1.	Models 5315A and 5315B Universal Counters	1-0
2-1.	5315A Line Voltage Selection Label	2-1
2-2.	5315B Line Voltage Selection Card	2-2
2-3.	Power Cable HP Part Numbers versus Mains Plugs Available	2-3
3-1.	T.I. Average Dead Time	3-2
3-2.	Timing of Time Interval Delay Mode	3-3
3-3.	Timing of Totalize A by B Mode	3-4
3-4.	A ARMED BY B	3-5
3-5.	Trigger Level/Sensitivity Controls	3-8
3-6.	5315A/B Front End Block Diagram	3-9
3-7.	Front Panel Features	3-10
3-8.	Rear Panel Features	3-13
3-9.	Operator's Check	3-16
3-10.	AC Coupled Measurements	3-17
3-11.	DC Coupled Measurements	3-17
3-12.	Details of Input Connector J1 and Fuse Mounting	3-19
3-13.	Frequency A/Period A Measurements	3-21
3-14.	Time Interval Measurement	3-22
3-15.	Time Interval Delay Measurement	3-23
3-16.	Time Interval Average A—B	3-24
3-17.	Ratio A/B Measurements	3-25
3-18.	A BY B Measurements	3-26
3-19.	FREQ A Armed by B Measurements	3-27
3-20.	Totalize Measurement	3-28
3-21.	Frequency C Measurement (Option 003)	3-29
4-1.	Channel C Frequency Response and Sensitivity Test Setup	4-11
5-1.	5315A Adjustment Component Locations	5-3
5-2.	5315B Adjustment Component Locations	5-5
5-3.	Reference Oscillator Adjustment Locations (Standard and Option 001)	5-7
5-3.	Reference Oscillator Adjustment Locations (Option 004)	5-8
5-4.	Option 002 Battery Charger Adjustment Locations	5-10
5-5.	Option 003 Channel C Adjustment Locations	5-14
6-1.	Model 5315A Mechanical Parts Layout	6-23
6-2.	Model 5315B Mechanical Parts Layout	6-24
6-3.	Option 002, Rechargeable Battery	6-25
6-4.	Option 003	6-26
6-5.	Option 004	6-27
7-1.	Adjustment Component Locator A1 (A1 Assembly Series 1812 through 1928)	7-3
7-1.	A1S1 Switch Assembly (A1 Assembly Series 1928)	7-3
7-3.	Option 002 Battery Charger Adjustment Locations (A6 Assembly Series 1812 through 2032)	7-5
7-4.	A1/A2/A5/A7/A8 Motherboard/Display Schematic Diagram	7-13
7-5.	A6 Battery Charger Schematic Diagram	7-14

LIST OF FIGURES

Figure		Page
8-1.	Schematic Diagram Notes	8-2
8-2.	Overall Block Diagram	8-6
8-3.	Battery-Pack (Option 002) Block Diagram	8-11
8-4.	Option 003 1 GHz C Channel Block Diagram	8-14
8-5.	A3/A4 Input Assembly Waveforms	8-19
8-6.	Troubleshooting Block Diagram	8-25
8-7.	Top Internal Model 5315A	8-26
8-8.	Top Internal Model 5315B	8-27
8-9.	5315A A1 Motherboard/Power Supply Component Locator	8-28
8-10.	A2 Display Assembly Component Locator	8-29
8-11.	A7 TCXO Assembly Component Locator	8-30
8-12.	A13 Standard Reference Oscillator Component Locator	8-30
8-13.	A14 Oven Reference Oscillator Assembly (5315A Option 004) Component Locator	8-30
8-14.	5315A-A1/A2/A5/A7/A13/A14 Motherboard/Display Schematic Diagram	8-31
8-15.	5315B A1 Motherboard Component Locator	8-32
8-16.	5315B A1/A2/A5/A7/A8/A13/A15 Motherboard/Display Schematic Diagram	8-33
8-17.	A3 Input Component Locator	8-34
8-18.	A4 Input Assembly Component Locator	8-35
8-19.	A3/A4 Input Switch/Amplifier Schematic Diagram	8-35
8-20.	A6 Battery Charger Component Locator	8-36
8-21.	A6 Battery Charger Schematic Diagram	8-37
8-22.	A9 C Channel Component Locator	8-38
8-23.	Option 003 A9 C Channel Waveforms	8-39
8-24.	A9 C Channel Schematic Diagram	8-39

SAFETY CONSIDERATIONS

GENERAL

The following safety considerations should be read and fully understood before operating the HP Model 5315 series Universal Counters.

OPERATION

BEFORE APPLYING POWER verify that the power transformer primary is matched to the available line voltage and the correct fuse is installed (see Section II). Make sure that only fuses with the required rated current and of the specified type (normal blow, time delay, etc.) are used for replacement. The use of repaired fuses and the short-circuiting of fuseholders must be avoided.

SERVICE

Although this equipment has been designed in accordance with international safety standards, this manual contains information, cautions, and warnings that must be followed to ensure safe operation and to retain the equipment in safe condition. Service and adjustments should be performed only by qualified service personnel.

Any adjustment, maintenance, and repair of the opened equipment under voltage should be avoided as much as possible and, when inevitable, should be carried out by a skilled person who is aware of the hazard involved.

Capacitors inside the equipment may still be charged even if the equipment has been disconnected from its source of supply.

When it is likely that the protection has been impaired, the equipment must be made inoperative and be secured against any unintended operation.

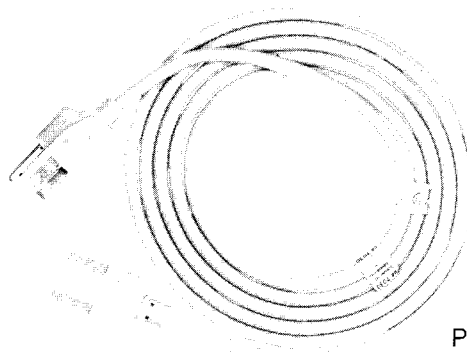

Figure 1-1. Models 5315A and 5315B Universal Counters

SECTION I GENERAL INFORMATION

1-1. INTRODUCTION

1-2. This manual provides information about installation, operation, testing, adjustments, and servicing the Hewlett-Packard Model 5315A and 5315B Universal Counters, shown in *Figure 1-1*.

1-3. The 5315B is functionally identical to the 5315A. The major difference is that the 5315B is designed for rack mounting or stacking and features a metal cabinet to minimize electro-magnetic interference. (The 5315A has a high-strength plastic cabinet.)

1-4. This manual has eight sections, each covering a particular topic for using and servicing the 5315A and 5315B. The topics by section number are:

Section	Topic
I	General Information
II	Installation
III	Operation
IV	Performance Tests
V	Adjustments
VI	Replaceable Parts
VII	Manual Changes
VIII	Service

1-5. DESCRIPTION

1-6. The HP 5315A and 5315B are universal counters, measuring signals over a range from 0.1 Hz to 100 MHz. The 5315A and 5315B measure frequency, period, time interval, time interval average, time interval holdoff (delay), and ratio. A totalize function with manual or external gating is also provided. All measurements except totalize are displayed in scientific notation with up to eight digits of resolution.

1-7. Two independent input channels provide time interval measurements. Each input channel has an attenuator (X1, X20), trigger slope selector, trigger level and sensitivity control, and AC-DC coupling. A switchable low-pass filter on Channel A and three-state trigger lights are also provided.

1-8. Option 003, 1 GHz third or "C" input channel for the 5315A/B, provides frequency measurements from 50 MHz to 1 GHz. The input sensitivity is 15 mV for frequencies between 50 and 650 MHz, and 75 mV for frequencies between 650 MHz and 1 GHz. The C Channel is a 50-ohm input with a dynamic input range of 1V rms. The input is prescaled by 10 to achieve a 1 GHz frequency range. Complete specifications for the Option 003 are listed in *Table 1-1*.

1-9. SPECIFICATIONS

1-10. The instrument specifications are listed in *Table 1-1*. These specifications are the performance standards or limits against which the instrument may be tested.

Table 1-1. 5315A/B Specifications*

INPUT CHARACTERISTICS: (Channel A and Channel B)

Range:

DC coupled, 0 to 100 MHz.
AC coupled, 30 Hz to 100 MHz.

Sensitivity:

10 mV rms sine wave to 10 MHz.
25 mV rms sine wave to 100 MHz.
75 mV peak-to-peak pulse at minimum pulse width of 5 ns.

Sensitivity can be varied continuously up to 500 mV rms **NOMINAL** by adjusting SENSITIVITY control. In SENSITIVITY mode, trigger level is automatically set to 0V **NOMINAL**.

Dynamic Range:

30 mV to 5V peak-to-peak, 0 to 10 MHz.
75 mV to 5V peak-to-peak, 10 to 100 MHz.

Signal Operating Range: +2.5V DC to -2.5V DC.

Coupling: AC or DC, switchable.

Filter: Low pass, switchable in or out of Channel A.
3 dB point of **NOMINALLY** 100 kHz.

Impedance: 1 MΩ **NOMINAL** shunted by less than 40 pF.

Attenuator: X1 or X20 **NOMINAL**.

Trigger Level: Variable between +2.5V DC and -2.5V DC.

Slope: Independent selection of + or - slope.

Common Input: All specifications are the same for

Common A except the following:

Sensitivity: 20 mV rms to 10 MHz, 50 mV rms to 100 MHz,
150 mV peak-to-peak.

Dynamic Range: 60 mV-5V peak-to-peak 0-10 MHz,
150 mV-5V peak-to-peak 10-100 MHz.

Impedance: 500 kΩ (Nom) shunted by less than 70 pF.

Damage Level:

AC&DC × 1:

DC to 2.4 kHz 250V (DC + AC rms)
2.4 kHz to 100 kHz 6 × 10⁵V rms Hz/FREQ
>100 kHz 6V rms

AC&DC × 20:

DC to 28 kHz 500V (DC + AC peak)
28 kHz to 100 kHz 1 × 10⁷V rms Hz/FREQ
>100 kHz 100V rms

FREQUENCY (Channel A)

Range: 0.1 Hz to 100 (burst or cw).

NOTE

Between 0.1 Hz and 0.14 Hz, the resolution is one millihertz.

LSD Displayed: 10 Hz to 1 nHz depending upon gate time and input signal. At least 7 digits displayed per second of gate time.

****Resolution:**

$$\pm \text{LSD} \dagger \pm 1.4 \times \frac{\text{Trigger Error}}{\text{Gate Time}} \times \text{FREQ}, \text{FREQ} < 10 \text{ MHz.}$$

$$\pm \text{LSD} \dagger, \geq 10 \text{ MHz.}$$

Accuracy: ±Resolution ± (time base error) × FREQ.

****Best Case Resolution for 1 Second Gate**

	100 Hz	1 kHz	10 kHz	100 kHz	1 MHz	10 MHz	100 MHz
50 mV rms	±.0004 Hz	±.00048 Hz	±0.0014 Hz	±0.01 Hz	±0.1 Hz	±1 Hz	±10 Hz
100 mV rms	±.0002 Hz	±.00029 Hz	±0.0012 Hz	±0.01 Hz	±0.1 Hz	±1 Hz	±10 Hz
500 mV rms	±.00005 Hz	±.00014 Hz	±0.0011 Hz	±0.01 Hz	±0.1 Hz	±1 Hz	±10 Hz
1V rms	±.00003 Hz	±.00012 Hz	±0.0010 Hz	0.01 Hz	±0.1 Hz	±1 Hz	±10 Hz

This chart shows best case frequency reduction versus input sinewave rms amplitude. This is best case because noise from the signal source is assumed to be zero; the trigger error is produced only by the counter's noise (i.e., 120 μV rms).

PERIOD

Range: 10 ns to 10⁵ s.

LSD Displayed: 100 ns to 1 fs depending upon gate time and input signal. At least 7 digits displayed per second of gate time.

Resolution:

$$\pm \text{LSD} \dagger \pm 1.4 \times \frac{\text{Trigger Error}}{\text{Gate Time}} \times \text{PER}, \text{PER} > 100 \text{ ms.}$$

$$\pm \text{LSD} \dagger, \text{PER} \leq 100 \text{ ns.}$$

Accuracy: ± Resolution ± (time base error) × PER.

TIME INTERVAL

Range: 100 ns to 10⁵ s.

LSD Displayed: 100 ns.

Resolution: ± LSD ± Start Trigger Error ± Stop Trigger Error.

Accuracy: ± Resolution ± (time base error) × TI.

TIME INTERVAL AVERAGE

Range: 0 ns to 10⁵ s.

LSD Displayed: 100 ns to 10 ps depending upon gate time and input signal. See table in Definitions section.

Resolution:

$$\pm \text{LSD} \pm \frac{\text{Start Trigger Error}}{\sqrt{N}} \pm \frac{\text{Stop Trigger Error}}{\sqrt{N}}$$

Accuracy: ± Resolution ± (time base error) × TI ± 4 ns.

Number of intervals averaged (N): N = Gate Time × FREQ.

Minimum Dead Time (stop to start): 200 ns.

TIME INTERVAL DELAY (Holdoff)

Front panel gate time knob inserts a variable delay of **NOMINALLY** 500 μs to 20 ms between START (Channel A) and enabling of STOP (Channel B). Electrical inputs during delay time are ignored. Delay time may be digitally measured by simultaneously pressing T.I. Averaging, T.I. Delay, and blue key. Other specifications of T.I. Delay are identical to Time Interval.

RATIO

Range: 0.1 Hz to 100 MHz, both channels.

LSD:

$$\frac{2.5 \times \text{Period A}}{\text{Gate Time}} \times \text{Ratio. (rounded to nearest decade)}$$

Resolution:

$$\pm \text{LSD} \pm \frac{B \text{ Trigger Error}}{\text{Gate Time}} \times \text{Ratio.}$$

Accuracy: Same as resolution. Highest frequency input is connected to Channel A to achieve specified accuracy.

TOTALIZE

Manual:

Range: 0 to 100 MHz.

A Gated by B:

Totalizes input A between two events of B.

Instrument must be reset to make new measurement. Gate opens on A slope, closes on B slope.

Range: 0 to 100 MHz.

Resolution: ± 1 count.

Accuracy: ± 1 count ± B Trigger Error × Frequency A.

*Specifications describe the instrument's warranted performance. Supplemental characteristics are intended to provide information useful in applications of the instrument by giving **TYPICAL** or **NOMINAL**, but nonwarranted performance parameters. Definition of terms is provided at the end of the specification section. For a more detailed explanation, see HP Application Note 200-4 "Understanding Frequency Counter Specifications".

Table 1-1. 5315A/B Specifications (Continued)

TIME BASE	WARRANTY
<p>Frequency: 10 MHz. Aging Rate: <3 parts in 10⁷/mo. Temperature: ≤±5 parts in 10⁶, 0 to 50°C. Line Voltage: ≤±1 part in 10⁷ for ±10% variation.</p>	<p>ALL COMPONENTS IN OPTION 002, EXCEPT THE BATTERY, ARE WARRANTED FOR ONE FULL YEAR. BATTERY BT-1, (HP PART NO. 1400-0253) IS NOT WARRANTED.</p>
GENERAL	
<p>Check: Counts internal 10 MHz reference frequency over gate time range NOMINALLY 500 μs to 20 ms. Error Light: LED warning light activated if logic error is found during instrument turn-on self-check. Display: 8-digit amber LED display, with engineering units annunciator. Overflow: Only frequency and totalize measurements will overflow. In case of overflow, eight least significant digits will be displayed and amber front panel overflow LED will be actuated. All other measurements which would theoretically cause a display of more than 8 digits will result in the display of the 8 most significant digits. Gate Time: Continuously variable, NOMINALLY from 60 ms to 10 s or 1 period of the input, whichever is longer. Sample Rate: Up to 5 readings per second NOMINAL except in time interval mode, where it is continuously variable NOMINALLY from 4 readings per second to 1 reading every 10 seconds via Gate Time control. Operating Temperature: 0° to 50°C. Power Requirements: Internally switch selectable 100, 120, 220, or 240V (+5%, -10%) 48-66 Hz; 15 VA maximum. Weight: Net, 2.2 kg (4 lbs. 12 oz.); Shipping, 4.1 kg (9 lbs.). Dimensions: 238 mm W × 98 H × 276 mm D (9³/₈ × 3⁷/₈ × 10⁷/₈ in.).</p>	<p>Option 003: C Channel</p> <p>Input Characteristics: Range: 50 to 1000 MHz, prescaled by 10. Sensitivity: 15 mV rms sine wave (-23.5 dBm) to 650 MHz. 75 mV rms sine wave (-9.5 dBm) to 1000 MHz. Sensitivity can be decreased continuously by up to 20 dB NOMINAL, 50 to 500 MHz and 10 dB NOMINAL, 500 to 1000 MHz by adjusting sensitivity control. Trigger level is fixed at 0V NOMINAL. Dynamic Range: 15 mV to 1V rms (36 dB), 50 to 650 MHz. 75 mV to 1V rms (20 dB), 650 to 1000 MHz. Signal Operating Range: +5 Vdc to -5 Vdc. Coupling: AC. Impedance: 50Ω NOMINAL (VSWR, <2.5:1 TYPICAL) Damage Level: ±8V (DC + AC peak), fuse protected. Fuse located in BNC connector.</p>
OPTIONS	
<p>Option 001: Temperature Compensated Time Base (TCXO) Frequency: 10 MHz. Aging Rate: <1 part in 10⁷/mo. Temperature: ≤1 part in 10⁶, 0° to 40°C. Line Voltage: <1 part in 10⁸ for ±10% variation.</p>	<p>Option 004 (for 5315A): High Stability Time Base (Oven Oscillator) Frequency: 10 MHz. Aging Rate: <1 part in 10⁷/mo. (after 10 day warm up). Temperature: ±1 part in 10⁷, 0° to 50°C. Line Voltage: ≤1 part in 10⁷ for ±10% variation.</p>
<p>Option 002: Battery (5315A only) Type: Rechargeable lead-acid (sealed). Capacity: TYPICALLY 4 hours of continuous operation at 25°C. Recharging Time: TYPICALLY 16 hours to 98% of full charge, instrument nonoperating. Charging circuitry included with Option. Batteries not charged during instrument operation. Low Voltage Indicator: Instrument turns itself off automatically when low battery conditions exists. Discharge LED flashes slowly when this happens. Discharge LED is on whenever battery is supplying power to instrument. Charge LED indicates state of charge of battery during charging only and is on whenever battery is charged to 95% NOMINAL of capacity. Charge LED flashes when 90% NOMINAL of charge taken out is replaced. Charge LED is off if charge is less than 70% NOMINAL of capacity.</p>	<p>Option 004 (for 5315B): High Stability Time Base (Oven Oscillator) Frequency: 10 MHz. Aging Rate: <5 parts in 10⁸/mo. Temperature: <2 parts in 10⁸, 0° to 67°C. Line Voltage: ≤1 part in 10⁷ for ±10% variation.</p>
<p>Line Failure Protection: Instrument automatically switches to battery in case of line failure. Weight: Option 002 adds 1.4 kg (3 lbs.) to weight of instrument.</p>	<p>5315B: Rack and stack metal case with rear panel, switchable AC power line module. Specifications same as 5315A except as follows: Rack Mount Kit: 5061-0072 recommended. Oscillator Output: 10 MHz, 50 mV p-p into 50Ω load on rear panel. External Frequency Standard Input: 10 MHz, 1V rms into 500Ω on rear panel. Requires internal selection. Dimensions: 212 mm W × 81 mm H × 345 mm D (8³/₈ × 3¹/₂ × 13³/₄ in.). Weight: Net, 3.2 kg (7 lbs. 2 oz.); Shipping, 4.5 kg (10 lbs.).</p>

Table 1-1. 5315A/B Specifications (Continued)

DEFINITIONS

Resolution: Smallest discernible change of measurement result due to a minimum change in the input.

Accuracy: Deviation from the actual value as fixed by universally accepted standards of frequency and time.

Least Significant Digit (LSD) Displayed:

Frequency:

$$\frac{2.5 \times 10^{-7}}{\text{Gate Time}} \times \text{FREQ}, \quad \text{FREQ} < 10 \text{ MHz.}$$

$$\frac{2.5}{\text{Gate Time}} \quad \text{FREQ} \geq 10 \text{ MHz.}$$

Period:

$$\frac{2.5 \times 10^{-7}}{\text{Gate Time}} \times \text{PER}, \quad \text{PER} > 100 \text{ ns.}$$

$$\frac{2.5}{\text{Gate Time}} \times \text{PER}^2, \quad \text{PER} \leq 100 \text{ ns.}$$

All above calculations should be rounded to nearest decade (i.e., 0.5 Hz will become 10 Hz and 0.4 ns will be 0.1 ns).

Time Interval Average

	LSD
1 to 25 intervals	100 ns
25 to 2500 intervals	10 ns
2500 to 250,000	1 ns
250,000 to 25,000,000 intervals	100 ps
>25,000,000 intervals	10 ps

Time Interval Average is a statistical process. LSD displayed is calculated for 1 standard deviation (σ) confidence level.

Trigger Error:

$$\frac{\sqrt{(120 \times 10^{-6})^2 + e_n^2}}{(\text{Input slew rate at trigger point})} \quad \text{seconds rms}$$

where e_n is the rms noise voltage of the input for a 100 MHz bandwidth.

NOTES:

†Due to arithmetic truncation, quantization error will be ± 1 or ± 2 counts of the LSD as follows:

$$\pm 2 \text{ counts of LSD if } \frac{\text{LSD}}{\text{FREQ or PER}} < 1 \times 10^{-7} \text{ FREQ} < 10 \text{ MHz.}$$

$$\pm 2 \text{ counts of LSD if } \frac{\text{LSD}}{\text{FREQ or PER}} < \frac{1/(\text{Gate Time})}{\text{FREQ}} \text{ FREQ} \geq 10 \text{ MHz.}$$

± 1 count of LSD for all other cases.

1-11. OPTIONS

1-12. The options available for the 5315A/B are listed below. Specifications for the options are given in *Table 1-1* and full descriptions begin with paragraph 3-62. If an option is included in the initial order, it will be installed at the factory and will be ready for operation upon receipt. Options 002 and 006 are available as retrofit kits for field installation. For field installation of Options 001, 002, 003, and 004, refer to the appropriate installation instructions in Section II. The Option 006 retrofit kit contains installation instructions.

Option	Description
001	Temperature Compensated Time Base TCXO*
002	Battery and Charger (for Model 5315A only)
003	C Channel 1 GHz Input
004	High Stability Time Base—Oven-Contained Oscillator*
006	Offset/Normalizer (Used with Model 5315B only)

*Only one of either Option 001 or 004 can be installed.

NOTE

For Model 5315A (only), one of the following options *must* be included with each order.

- Option 100: 90-105 VAC; 48-66 Hz
- Option 120: 108-126 VAC; 48-66 Hz
- Option 220: 198-231 VAC; 48-66 Hz
- Option 240: 216-252 VAC; 48-66 Hz

1-13. SAFETY CONSIDERATIONS

1-14. The 5315A/5315B Universal Counters are Safety Class I instruments, designed according to international safety standards. This operating and service manual contains information, cautions, and warnings which must be followed by the user to ensure safe operation and keep the instrument in safe condition.

1-15. INSTRUMENT IDENTIFICATION

1-16. Hewlett-Packard instruments have 2-section, 10-character serial numbers (0000A00000), usually on the rear panel. The four-digit serial prefix identifies instrument changes. If the serial prefix of your instrument differs from that listed on the title page of this manual, there are differences between this manual and your instrument. Instruments having higher serial prefixes are covered with a "Manual Changes" sheet included with this manual. If the change sheet is missing, contact the nearest Hewlett-Packard Sales and Service Office listed at the back of this manual. Instruments having a lower serial prefix number than that listed on the title page are covered in Section VII.

1-17. ACCESSORIES

1-18. Table 1-2 lists accessory equipment supplied and Table 1-3 lists accessories available.

Table 1-2. Accessories Supplied

Description	HP Part Number
Detachable Power Cord, 229 cm (7½ feet)	8120-1378

Table 1-3. Accessories Available

Description	HP Part Number
Rack Mount Kit (5315B Only)	5061-0072

1-19. RECOMMENDED TEST EQUIPMENT

1-20. The test equipment listed in Table 1-4 is recommended for use during performance tests, adjustments, and troubleshooting. Substitute test equipment may be used if it meets the critical specifications listed in the table.

Table 1-4. Recommended Test Equipment

Instrument	Critical Specifications	Recommended Model	Use
Oscilloscope	100 MHz Bandwidth	HP 1740A	A,T
Synthesizer/Function Generator	0.1—10 MHz, 5—120 mVrms Sine and Square wave output	HP 3325A	P,A,T
Signal Generator	10—100 MHz, 5—100 mVrms	HP 8654A	P
Synthesized Generator	50—1000 MHz, +1 to -14 dBm	HP 8660C/86602A	P
DC Voltmeter	20V Range, 0.05V Resolution	HP 3465A	A,T
50Ω Feedthrough (2 required)	BNC Type		P,A,T
Tee Connector	BNC Type	1250-0781	A,T
Power Splitter	50 MHz—1 GHz; Calibrated Output	HP 11667A	P
Cables (3)	4 BNC 50Ω	11170C	A,T
Power Meter/Sensor	50 MHz—1 GHz; -9 to -24 dBm	HP 436A/8481A	P
10 dB Attenuator		HP 8491A	P
Adapter, Coaxial (2 required)	Type N (male)-to- BNC (female)	1250-0780	P
Adapter, Coaxial	Type N (male)-to- BNC (male)	1250-0082	P

*P = Performance Tests, A = Adjustments, T = Troubleshooting

SECTION II INSTALLATION

2-1. INTRODUCTION

2-2. This section contains information for unpacking, inspection, storage, and installation.

2-3. UNPACKING AND INSPECTION

2-4. If the shipping carton is damaged, inspect the instrument for visible damage (scratches, dents, etc.). If the instrument is damaged, notify the carrier and the nearest Hewlett-Packard Sales and Service Office immediately (offices are listed at the back of this manual.) Keep the shipping carton and packing material for the carrier's inspection. The Hewlett-Packard Sales and Service Office will arrange for repair or replacement of your instrument without waiting for the claim against the carrier to be settled.

2-5. PREPARATION FOR USE

2-6. Power Requirements

2-7. The HP 5315A/B requires a power source of 100-, 120-, 220-, or 240-volt ac, +5%, -10%, 48 to 66 Hz single phase. Power consumption is approximately 12 watts. The 5315A (only) may also be powered by the Option 002 Battery Pack. See Section I, Specifications and Section VIII, paragraph 8-65, for description.

2-8. Line Voltage Selection

CAUTION

Before connecting the instrument to ac power lines, be sure that the voltage selector is properly positioned as described below.

2-9. The 5315A is preset at the factory to one of four line voltage selections. Refer to the rear panel label (see *Figure 2-1*) to determine which of the following settings is preselected:

- Option 100: 90 to 105 VAC; 48-66 Hz
- Option 120: 108 to 126 VAC; 48-66 Hz
- Option 220: 198 to 231 VAC; 48-66 Hz
- Option 240: 216 to 252 VAC; 48-66 Hz

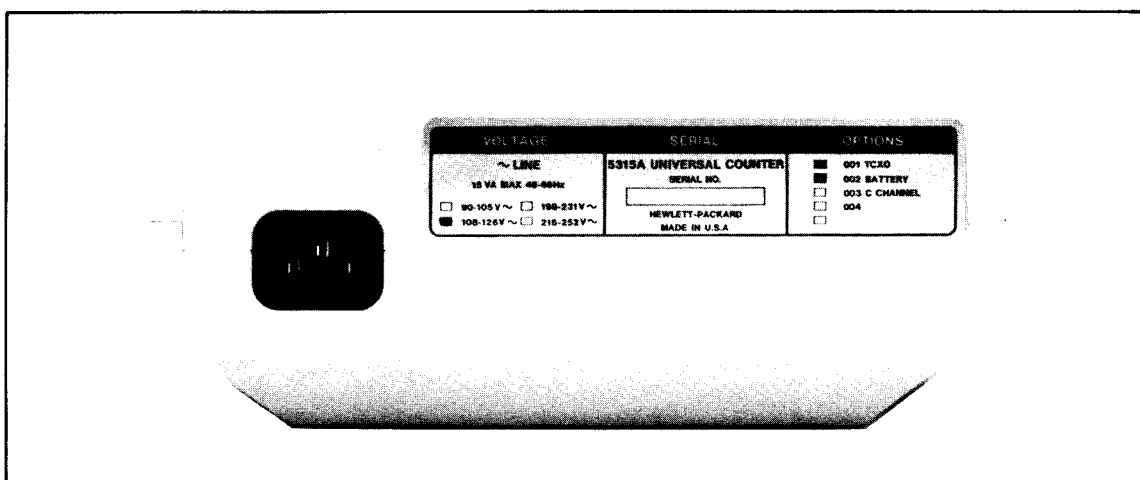

Figure 2-1. 5315A Line Voltage Selection Label

2-10. Changing the 5315A power line voltage selector requires opening the cabinet. Instructions for changing the line voltage setting are given in Section V.

2-11. The 5315A has a rear-panel power module that contains a printed-circuit line voltage selector to select 100-, 120-, 220-, or 240-volt ac operation (see Figure 2-2). Before applying power, the pc selector must be set to the correct position and the correct fuse must be installed as described below.

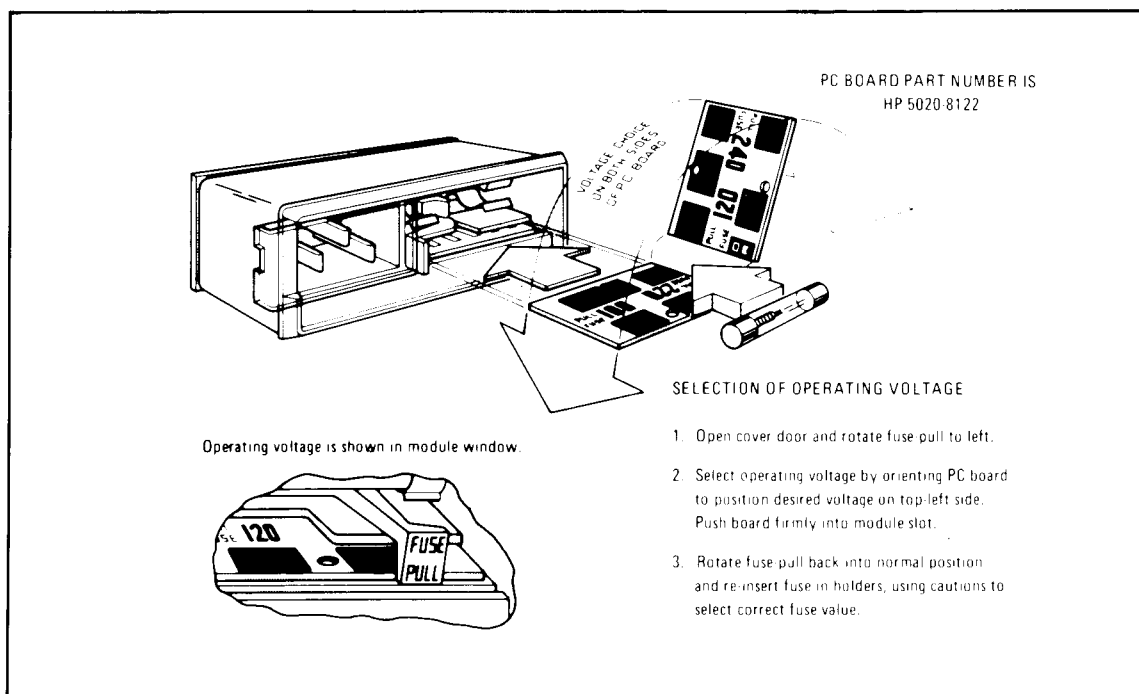

Figure 2-2. 5315B Line Voltage Selection Card

2-12. Power line voltage connections are selected by the position of the plug-in circuit card in the module. When the card is plugged in to the module, the only visible markings on the card indicate the line voltage to be used. The correct value of line fuse, with a 250-volt rating, must be installed after the card is inserted. This instrument uses a 0.25A fuse (HP Part No. 2110-0201) for 100/120-volt operation; a 0.12A fuse (HP Part No. 2110-0318) for 220/240-volt operation.

2-13. To convert from one line voltage to another, the power cord must be disconnected from the power module before the sliding window covering the fuse and card compartment can be moved to expose the fuse and circuit card.

2-14. Pull on the fuse lever to remove the fuse and then pull the card out of the module. The fuse lever must be held to one side to extract and insert the card. Insert the card so the marking that agrees with the line voltage to be used is visible.

2-15. Return fuse lever to normal position, insert correct fuse, slide plastic window over the compartment, and connect the power cord to complete the conversion.

2-16. Power Cable

WARNING

BEFORE SWITCHING ON THIS INSTRUMENT, THE PROTECTIVE EARTH TERMINALS OF THIS INSTRUMENT MUST BE CONNECTED TO THE PROTECTIVE CONDUCTOR OF THE (MAINS) POWER CORD. THE MAINS PLUG SHALL ONLY BE INSERTED IN A SOCKET OUTLET PROVIDED WITH A PROTECTIVE EARTH CONTACT. THE PROTECTIVE ACTION MUST NOT BE NEGATED BY THE USE OF AN EXTENSION CORD (POWER CABLE) WITHOUT A PROTECTIVE CONDUCTOR (GROUNDING).

2-17. The 5315A/B is shipped with a three-wire power cable. When the cable is connected to an appropriate ac power source, this cable connects the chassis to earth ground. The type of power cable plug shipped with each instrument depends on the country of destination. Refer to Figure 2-3 for the part numbers of the power cable and plug configurations available.

2-18. Operating Environment

2-19. TEMPERATURE. The 5315A/B may be operated in temperatures from 0°C to 50°C.

2-20. HUMIDITY. The 5315A/B may be operated in environments with humidity up to 95%. However, it should be protected from temperature extremes which cause condensation in the instrument.

2-21. ALTITUDE. The 5315A/B may be operated at altitudes up to 4,600 metres (15,000 feet).

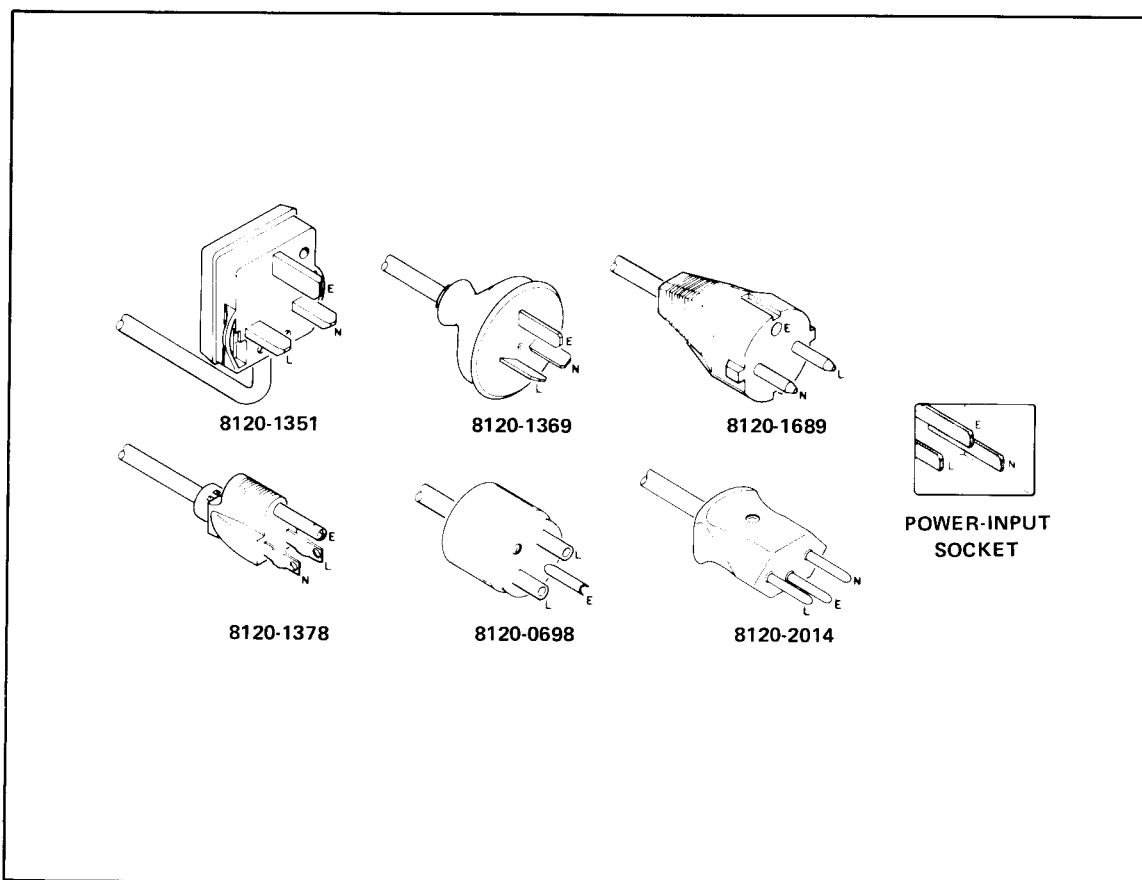

Figure 2-3. Power Cable HP Part Numbers versus Mains Plugs Available

2-22. STORAGE AND SHIPMENT

2-23. Environment

2-24. The instrument may be stored or shipped in environments with the following limits:

Temperature	-40°C to +75°C
Humidity	Up to 95%
Altitude	7,620 metres (25,000 feet)

2-25. The instrument should also be protected from temperature extremes which cause condensation within the instrument.

2-26. Packaging

2-27. ORIGINAL PACKAGING. Containers and materials identical to those used in factory packaging are available through Hewlett-Packard offices. If the instrument is being returned to Hewlett-Packard for servicing, attach a tag indicating the type of service required, return address, model number, and full serial number. Also, mark the container FRAGILE to ensure careful handling. In any correspondence, refer to the instrument by model number and full serial number.

2-28. OTHER PACKAGING. The following general instructions should be used for repacking with commercially available materials:

- a. Wrap instrument in heavy paper or plastic. (If shipping to Hewlett-Packard office or service center, attach a tag indicating type of service required, return address, model number, and full serial number.)
- b. Use a strong shipping container. A double-wall carton made of 2.4 MPa (350 psi) test material is adequate.
- c. Use a layer of shock-absorbing material 70 to 100 mm (3- to 4-inches) thick around all sides of the instrument to provide firm cushioning and prevent movement inside the container. Protect control panel with cardboard.
- d. Seal the shipping container securely.
- e. Mark the shipping container "FRAGILE" to ensure careful handling.
- f. In any correspondence, refer to the instrument by model number and full serial number.

2-29. FIELD INSTALLATION OF OPTIONS

2-30. The following paragraphs provide instructions for field installation of Options 001, 002, 003, and 004. Any of the options may be installed after the purchase of the Model 5315A or 5315B by ordering the appropriate parts listed in *Table 2-1* and performing the installation procedure for that option. Field installation instructions for the Model 5315B Option 006 are contained in the Installation and Service Manual.

2-31. Part Numbers for Ordering Option Kits

2-32. To obtain the necessary parts for installation of an option, order by part number as listed below (refer to Section VI for ordering information).

Table 2-1. Option Parts for Field Installation

Option	Description	HP Part Number
001	Temperature Compensated Time Base*	05315-60007
002	Battery Pack Retrofit Kit For 5315A with serial numbers prefixed 2120A and above	05315-60113
	For 5315A with serial numbers prefixed 1812A through 2032A	05315-60105
003	Channel C (Input to 1 GHz)	
	Channel C Assembly A9	05315-60009
	Special BNC Connector	05305-60205
	Teflon Insulator	05305-20105
	Hex Nut	0590-0038
	Lockwasher	2190-0124
	Connector	05305-60206
	Fuse .125A	2110-0301
	Front Panel (5315A; serial numbers prefixed 2120A and above)	05315-00027
	Front Panel (5315A; serial numbers prefixed 1812A through 2032A)	05315-00004
	Front Panel (5315B; serial numbers prefixed 2120A and above)	05315-00029
Front Panel (5315A; serial numbers prefixed 2120A and above)	05315-00008	
Screws 6-32 × .250" Pan Head Pozidriv (4 each)	2360-0113	
Reset Cable Assembly (W2); used on instruments with serial numbers prefixed 1812A to 1920A.	05315-60106	
004; 5315A	Oven-Contained Time Base*	05315-60017
004; 5315B	Oven-Contained Time Base*	05315-60112
	Screws securing Oscillator Mounting Bracket to left side frame and A1 motherboard.	2360-0115
	6-32 × .312" Pan Head Pozidriv w/lock (4 each)	2360-0113
006; 5315B	Offset/Normalizer Module** Retrofit Kit	05315-60110

*The mounting hardware for the standard oscillator is used to mount Options 001 and 004 (5315A), or the A15A1 Assembly of Option 004 (5315B).

**Includes installation instructions, parts and hardware.

2-33. Installation of TCXO Option 001

2-34. Option 001 consists of a Temperature Compensated Crystal Oscillator, which replaces the standard oscillator. To install Option 001, proceed as follows:

- a. Remove the AC power cord.
- b. Remove the instrument top cover. For Model 5315A, this requires removal of the four screws accessible from the cabinet bottom. For Model 5315B, loosen the single screw on the top rear center of the top cover and slide top backwards.
- c. Remove the A1 Motherboard by removing the three screws located on either side of transformer T1, and center of the board. Save the four plastic spacers.
- d. Remove the two screws that secure the existing reference oscillator; remove the oscillator circuit board.
- e. Insert the A7 TCXO assembly, with components facing to the outside of the instrument, into J2 of the A1 Motherboard assembly. See *Figure 5-3*.
- f. Secure the assembly by installing the two screws through L-brackets with lockwashers and hex nuts.
- g. Perform Option 001 adjustment as described in Section V.
- h. Replace A1 Motherboard, the four spacers and the top cover.

2-35. Installation of Battery Pack and Charger Option 002

2-36. Option 002 consists of a rechargeable battery and charger assembly (A6), which are installed in the top cover of Model 5315A. To install Option 002, proceed as follows:

NOTE

Option 002 may be installed only in Model 5315A. Installation should be performed by qualified service personnel only.

- a. Remove the AC power cord.
- b. Remove the instrument top cover by removing the four screws accessible from the cabinet bottom.
- c. Position the bracket assembly, with A6 and BT1 installed, onto the six mounting posts on the inside top cover, placing the charger toward the front and the battery toward the rear of the instrument. Secure with six press-on retainers supplied. The “ground clip” should be positioned as shown in *Figure 5-4*.
- d. Connect J1 of the A6 Charger assembly to J4 of the A1 Motherboard assembly using cable harness supplied. Position cable negative battery terminal lead beside the battery cover (refer to *Figure 5-3*).

NOTE

Connectors on this harness are polarized; do not force the connectors.

- e. If the oven oscillator (Option 004) is installed, add a short insulated jumper wire at A1W1 (refer to the 5315A A1 Assembly Schematic).
- f. Perform the Option 002 adjustment as described in Section V.
- g. Replace the top cover. Position the cable harness so the cable will not be pinched by the cover.

2-37. Installation of C Channel Option 003

2-38. Option 003 consists of a 1 GHz Channel Assembly (A9) which plugs into an existing motherboard connector. Procedures are provided for the installation of Option 003 in Model 5315A (paragraph 2-39) and Model 5315B (paragraph 2-40).

NOTE

If Option 003 is to be installed in a 5315A/B with a Serial Prefix of 1920A or earlier, the following modifications *must* be performed.

1. On A1 Motherboard, using diagonal pliers, clip off pin 1 of A1J6.
2. On A9 C Channel, install the RESET CABLE W2 (HP Part No. 05315-60106), by soldering the end (opposite the connector pin) into the vacant printed circuit pad next to pin 1 of P1.
3. Perform the following installation procedure. When finished, insert the connector end of RESET CABLE W2 into A1J7, pin 15 to complete the installation.

2-39. To install Option 003 in HP Model 5315A, proceed as follows:

- a. Remove the AC power cord.
- b. Remove the instrument top cover (MP 12) by removing the four screws accessible from the cabinet bottom.
- c. Remove the LEVEL/SENS and GATE TIME control knobs.
- d. Remove the three screws which secure the motherboard to cabinet bottom. Remove the handle (MP 3) and the four black spacers (MP 4) and lift the entire instrument straight up and out.
- e. Remove the front panel hex nuts on the CHANNEL A and B BNC's and the three control hex nuts.
- f. Remove the 1/4" hex nut on the left rear side of the A2 Display Assembly. Pull the front panel (MP6) forward until it clears the control shafts and input jacks. Note the spacer between the front panel and A2 Assembly.

NOTE

If the old front panel has bezels installed in the holes, transfer them to the replacement panel.

- g. Remove the four screws securing the A4 Input Amplifier.
- h. Remove the A3/A4 assembly by gently lifting on the rear edge of A4, until the pins come free of motherboard connector A1 J5.
- i. Position the A9 C Channel assembly, component side up and protruding connector pins toward rear of instrument, over A1 motherboard jack J6. Install by gently pressing the row of connector pins into J6 until the assembly rests on the spacers mounted on A1. Secure with four screws provided.
- j. Install the Special Input BNC (provided) in the INPUT C position (center) of the 5315A replacement front panel (provided) as illustrated in Section III, *Figure 3-12*.
- k. Connect the SMC connector on A9 W1 to the INPUT C BNC; loosely install the new front panel; set the instrument into the cabinet bottom.

- l. Perform Option 003 adjustment as described in Section V.
 - m. Remove the instrument from the cabinet bottom and replace the A3/A4 Input Amplifier.
 - n. Position the front panel, and reinstall the CHANNEL A and B BNC and three control hex nuts. Replace the LEVEL/SENS and GATE TIME control knobs.
 - o. Reinstall the instrument into the cabinet bottom and secure with three screws. Replace the handle and four black spacers. Replace the cabinet top cover.
- 2-40. To install Option 003 in HP Model 5315B proceed as follows:
- a. Remove the AC power cord.
 - b. Remove the instrument top cover (MP 12) by removing the screw which secures the carrying handle (MP 11) at rear of instrument. Slide the cover backward until free.
 - c. Remove the gray trim strip (MP 16) from top of the instrument front frame (MP 17).
 - d. Remove the four screws which secure the front panel (MP 21). The front feet of the instrument must be removed to access the two screws on the frame bottom.

NOTE

Steps e & f apply only to instruments with serial numbers prefixed 1812A through 2032A. For all instruments, continue with step g.

- e. Remove the two screws which secure the support bracket, on the left side of A1 motherboard, to the instrument side frame.
- f. Remove the two screws and bracket which secure the A1 power supply heat sink to the instrument side frame.
- g. Remove the two screws at the rear edge of A1 motherboard.
- h. Disconnect the three power transformer secondary wires (BLU, BLU, WHT-BLU) from the A1 Motherboard, by pulling the push-on connectors straight up and off the test pins. Remove the OSC OUT wire which connects J8 to A1 Motherboard in the same manner.

NOTE

HP 5315B instruments with serial number 1832A00001 to 1832A00120 do not have "push on" connectors on the transformer secondary terminals or EXT REF wires. Carefully unsolder and resolder the wires on these instruments to complete installation.

- i. Carefully pull the entire instrument straight forward, through the front frame, and clear of the cabinet.
- j. Remove the LEVEL/SENS and GATE TIME front panel control knobs.
- k. Remove the front panel hex nuts on CHANNEL A and B INPUT BNC's and the three control hex nuts.
- l. Remove the 1/4" hex nut on the left side (back) of the A2 Display Assembly, and pull the front panel (MP21) straight forward, until clear. Note the spacer between the front panel and the A2 assembly.
- m. Remove the A3/A4 assembly by gently lifting on the rear edge of A4, until the pins come free of motherboard connector A1 J5.
- n. Position the A9 C Channel assembly, component side up with the protruding connector pins toward rear of instrument, over A1 motherboard jack J6. Install by gently pressing the row of connector pins into J6 until the assembly tests on the spacers mounted on A1. Secure with four screws provided.

- o. Install the Special Input BNC (provided) in the INPUT C position (center) of the 5315B replacement front panel (provided) as illustrated in Section III, *Figure 3-12*.
- p. Connect the SMC connector on A9W1 to the INPUT C BNC, and loosely install the new front panel.
- q. Position the cabinet and A1 motherboard assembly side by side, with the cabinet facing to the rear. Route the three power transformer secondary wires through the cabinet side frame and reconnect to A1 motherboard test pins. Ensure the wire colors match the pins as labeled.
- r. Carefully replace AC power cord, and perform Option 003 adjustment as described in Section V.
- s. Disconnect the power transformer secondary wires. Reinstall the A3/A4 Input Amplifier assembly.
- t. Reinstall the instrument into the cabinet by reversing steps a through l. Be sure that the A1 motherboard fits into the board guides.

2-41. Installation of Oven Oscillator Option 004 (5315A)

2-42. Option 004 consists of an oven-contained oscillator assembly (A14), which plugs into the reference oscillator connector J2 on the motherboard. Option 004 replaces the standard oscillator assembly (A13) or the TCXO assembly. To install Option 004 in the 5315A, proceed as follows:

- a. Remove the AC power cord.
- b. Remove the instrument top cover by removing the four screws accessible from the cabinet bottom.
- c. If battery pack Option 002 is installed, disconnect the 11-conductor cable assembly W4 at the motherboard connector.
- d. Remove the four spacers (MP4) and the three screws used to secure the A1 motherboard. Two of the screws are located on either side of transformer T1 with the other in the center of the board.
- e. Remove the two screws which secure the existing reference oscillator assembly. Remove the assembly.
- f. Position the A14 oven oscillator assembly with the components facing the left side of the instrument. Insert A14P2 into the motherboard jack (A1J2) from which the previous assembly was removed.
- g. Secure the assembly to the motherboard by installing the two screws through the L-brackets.
- h. If battery Option 002 is also installed, add a short insulated jumper wire on the A1 motherboard at the location labeled "W1."
- i. Perform the 5315A Option 004 adjustment as described in Section V.
- j. Install and secure A1 motherboard with the three screws. Replace the four spacers. Reconnect the battery option cable (if necessary). Install and secure the top cover with the four screws.

2-43. Installation of Oven Oscillator Option 004 (5315B)

2-44. Option 004 consists of an Oven Module Assembly (A15) with mounting bracket and an interconnect board, which plugs into the reference oscillator connector J2 on the A1 motherboard. This assembly replaces the standard oscillator assembly (A13) or the Option 001 TCXO assembly (A7). To install Option 004 in the 5315B, proceed as follows:

- a. Disconnect the 5315B power cord.
- b. Remove the instrument top cover (MP12) by removing the carrying handle screw (MP11) at rear of instrument. Slide the cover toward the rear until free.
- c. Remove the bottom cover (MP8) by loosening the captive screw (at the rear edge of the cover). Slide cover toward the rear until free.
- d. Remove the two screws which secure the existing reference oscillator assembly. Remove the assembly.
- e. Position the oven module and bracket assembly with the flat surface of the bracket facing the left side strut and the foot of the bracket over the hole near the center of the motherboard. Guide the bracket into place against the side strut. The lower edge of the bracket should be inserted in the space between the edge of the motherboard and the side strut, (between the rear deck and board guide).
- f. Secure the bracket to the side strut using three 6-32 × 3/8 inch screws; secure to motherboard using a similar screw.
- g. Insert the interconnect board (A15A1) into connector A1J2 of the motherboard assembly. The components should face the left side of instrument.
- h. Secure the interconnect board by installing the two 6-32 × 1/4 inch screws through the L-brackets.
- i. Perform Option 004 adjustment as described in Section V.
- j. Replace the bottom and top covers.

SECTION III OPERATION

3-1. INTRODUCTION

3-2. This section provides operating information for the 5315A/B Universal Counter. Descriptions of all front panel controls, connectors, and indicators as well as an operator's check, operating instructions, and operator's maintenance are provided.

3-3. OPERATING CHARACTERISTICS

3-4. The 5315A/B is a 100 MHz and 100 ns full universal counter, capable of Frequency, Period, Time Interval, Ratio, and Totalize type measurements. To maximize resolution, the 5315A/B uses a reciprocal counting technique for frequencies below 10 MHz, automatically switching to conventional frequency counting for frequencies above 10 MHz. The gate time is continuously adjustable from 50 ms to 10 s, on the front panel. The internal microcomputer performs the calculations, and automatically compensates for the arbitrary gate time. The display is given in scientific notation (i.e., exponents of blank, ± 3 , ± 6 , or ± 9). The input amplifiers are optimized for both time interval and frequency measurements.

3-5. When the optional third input channel is installed, the ("C") frequency range of the counter is extended to 1 GHz. The input sensitivity can be decreased, continuously, up to 20 dB nominally (in the range of 50 to 500 MHz) and 10 dB nominally (in the range of 500 to 1000 MHz).

3-6. MODES OF OPERATION

3-7. The 5315A/B provides ten modes of operation and two check functions. The resolution and accuracy for each mode except A Armed by B is provided in *Table 1-1*. The modes of operation are described in the following paragraphs:

- FREQ A (Frequency A)
- PER A (Period A)
- T.I. A→B [Time Interval A (start)-to-B (stop)]
- T.I. AVG. A→B (Time Interval Average A-to-B)
- T.I. DELAY (Holdoff)
- RATIO A/B (Ratio A-to-B)
- A BY B (Gated Totalize)
- A-Armed-By-B Mode
- FREQ C (Option 003)
- TOT (Manual Totalize)
- CHECK
- Display Check

3-8. FREQ A (Frequency A Mode)

3-9. Frequency measurements are made by connecting a signal (up to 100 MHz) to INPUT A, and pressing the FREQ A key (with the Blue shift key out). Select the appropriate input signal conditioning and adjust the LEVEL/SENS control (with TRIGGER LEVEL/SENSITIVITY key to TRIGGER LEVEL) to optimum trigger point. The optimum trigger point may be determined by centering the LEVEL/SENS control within the triggering range, indicated by the flashing trigger light. The GATE TIME control determines the resolution of the measurement, and may be displayed by pressing the GATE TIME function key and Blue shift key. The gate time range when FREQ A is pressed is 60 ms to 10 s, typical. However a gate time range of 500 μ s to 30 ms is available by pressing T.I. DELAY and TOT STOP/START simultaneously. When the Blue Shift key is OUT, the 5315A/B will be in FREQ A. When the Blue Shift key is IN, the 5315A/B will be in PER A. PER A is discussed in the following paragraph.

3-10. PER A (Period A Mode)

3-11. The Period A mode allows single period measurements to be made with periods of 100,000 seconds (28 minutes) to 10.0 nanoseconds into INPUT A. Select the appropriate input signal conditioning and Trigger Level/Sensitivity.

3-12. T.I. A→B [Time Interval A (start)-to-B (stop)] Mode

3-13. T.I. A→B measures the time interval between a START signal at INPUT A and a STOP signal at INPUT B. If both the START and STOP signals are derived from the same signal, connect the signal to INPUT A and set the SEP/COM A key to the COM A position (IN). Separate slope and Level/Sensitivity controls for each channel allow variable triggering on either positive or negative going slope. A single-shot time interval measurement may be made over a range of 100 nanoseconds up to 8 digits and 100,000 seconds after 9 digits.

3-14. T.I. AVG A→B (Time Interval Average A-to-B) Mode

3-15. The T.I. Average mode provides greater resolution of time interval measurements than single-shot T.I. mode. In the T.I. AVG mode, the gate time control varies the number of events of time intervals averaged (approximately GATE TIME \times REP RATE). The resolution of the measurement is improved by the \sqrt{N} , where N is the number of time intervals averaged. A limited range of negative T.I. measurements (i.e., B triggers before A) are possible in T.I. AVG mode.

3-16. In the T.I. AVG mode, there must be at least 200 ns dead time. Dead time occurs between the preceding time interval stop event and the current time interval start event, as shown in Figure 3-1. This means that in T.I. AVG mode, the repetition rate must be less than 5 MHz.

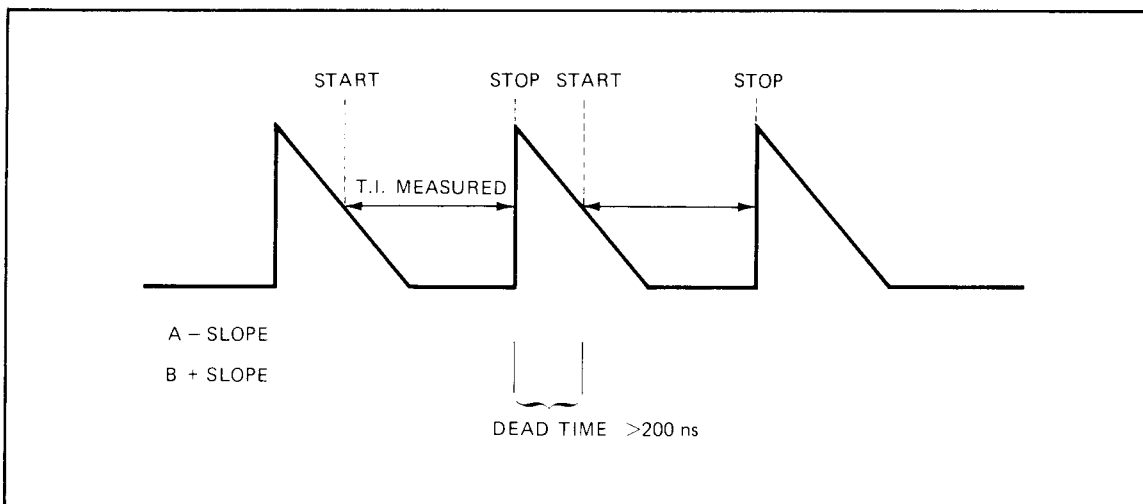

Figure 3-1. T.I. Average Dead Time

3-17. T.I. DELAY (Holdoff) Mode

3-18. The T.I. DELAY mode of operation is similar to T.I. A→B, but with the following additional control: The front panel GATE TIME control inserts a variable delay (from 500 μ s nominal to >20 ms) between the START (INPUT A) event and the enabling of the STOP (INPUT B) event. Potential STOP events are ignored during the specified delay or holdoff. The amount of delay time may be continuously measured and displayed by simultaneously pressing the T.I. A→B, T.I. DELAY, and Blue shift keys. Figure 3-2 illustrates the T.I. DELAY function.

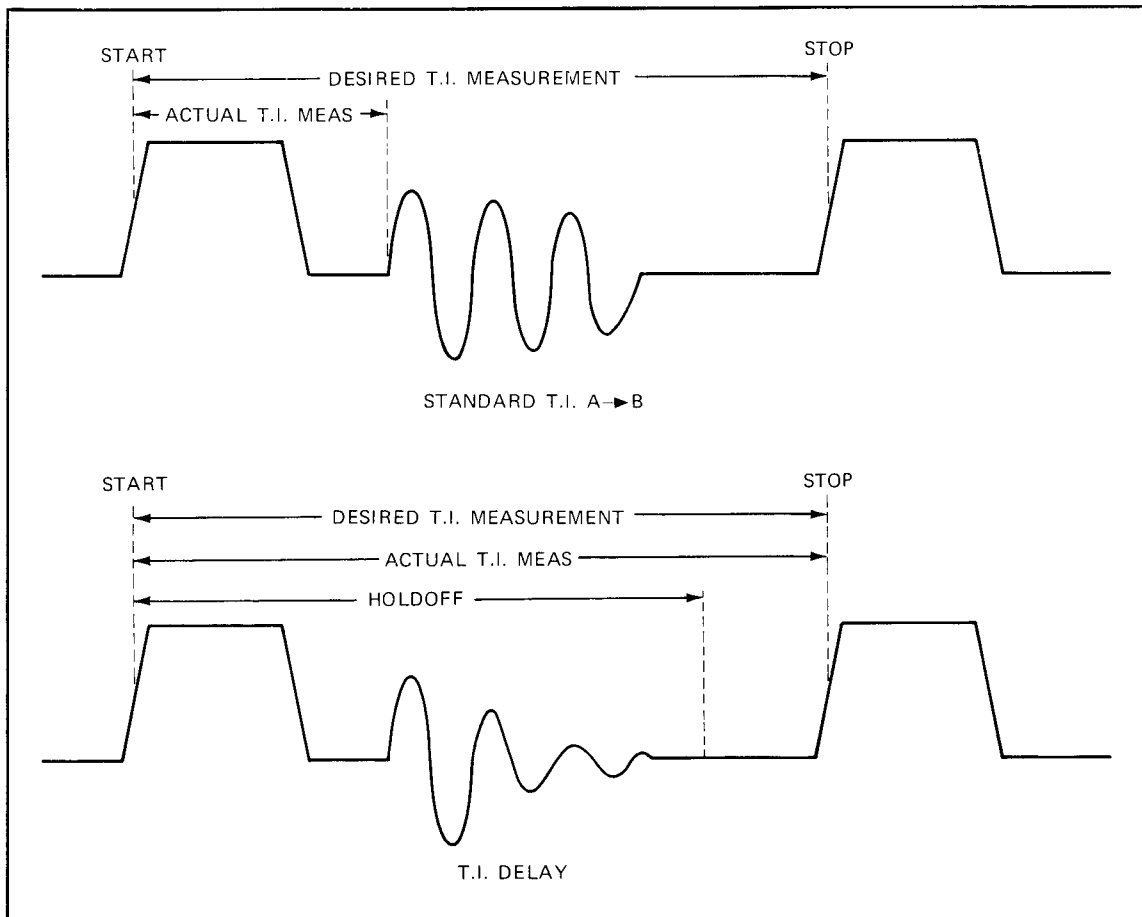

Figure 3-2. Timing of Time Interval Delay Mode

3-19. RATIO A/B

3-20. The RATIO A/B mode of operation measures and displays the frequency ratio of signals on INPUT A to signals on INPUT B. The GATE TIME control determines the resolution by selecting the number of cycles of the INPUT B signal over which the ratio A/B is measured. Increasing the gate time (towards MAX) or increasing the frequency of INPUT B results in an increased resolution of the measurement. Frequencies up to 100 MHz on both channels are allowed.

3-21. A BY B (Gated Totalize)

3-22. A BY B (A gated by B) is a totalize mode of operation (see *Figure 3-3*), in which events on INPUT A (up to 100 MHz) are counted for a duration determined by INPUT B. The gate is "OPENED" on the slope of Input B selected by the Channel A Slope switch, and "CLOSED" on the slope of Input B selected by the Channel B Slope switch. This allows any one of four discrete gate durations from a given signal on Input B. The Channel A slope switch also determines which slope of the events signal is counted on INPUT A. A BY B is a single-shot mode of operation. The RESET button must be pressed to clear the display and allow the initiation of a new measurement.

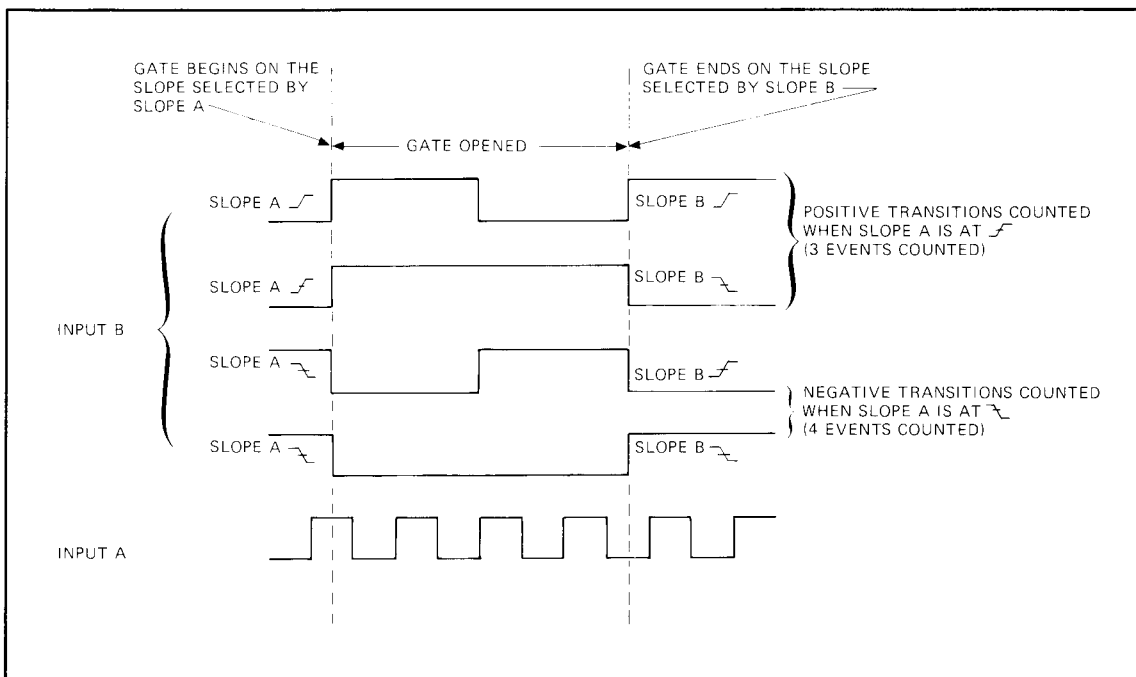

Figure 3-3. Timing of Totalize A by B Mode

3-23. A-ARMED-BY-B Mode

3-24. The 5315 has a measurement function, frequency-A-Armed-By-B, Averaged, for frequency averaging. Called "A ARMED BY B", this function allows the 5315 to average together multiple frequency measurements. To do this, a sampling signal synchronized with and of pulse width less than the signal bursts must be applied to the Channel B input. This signal performs two functions: one, it tells the 5315 when to count the incoming bursts and when to ignore the dead time between bursts; and two, it opens the 5315 gate. The measurement interval is set from the front panels and its length determines the number of bursts to be averaged. *Figure 3-4* shows an example of function A-Armed-By-B. In this example, 1MHz bursts, 10 μ s wide, at a 10 kHz repetition rate are applied to Channel A input. A sampling signal of equal repetition rate and shorter pulse width is applied to Channel B. This sampling signal must be synchronized with the Channel A frequency burst signal. When the first burst occurs, the sampling signal at Channel B opens the gate, and tells the 5315 to begin counting the events at Channel A. When the sampling signal disappears, the 5315 stops counting the events at Channel A. If the gate is still open and another burst occurs, the 5315 will add these "new" events to the previous events counted. This will continue until the measurement interval runs out. On the next sampling pulse, after the gate closes, the 5315 will compute the average frequency of the signal during the burst (in this example 1 MHz). A final sampling pulse **must** occur after the measurement interval ends to terminate the measurement. The events that occurred during this final pulse are not averaged in the displayed amount.

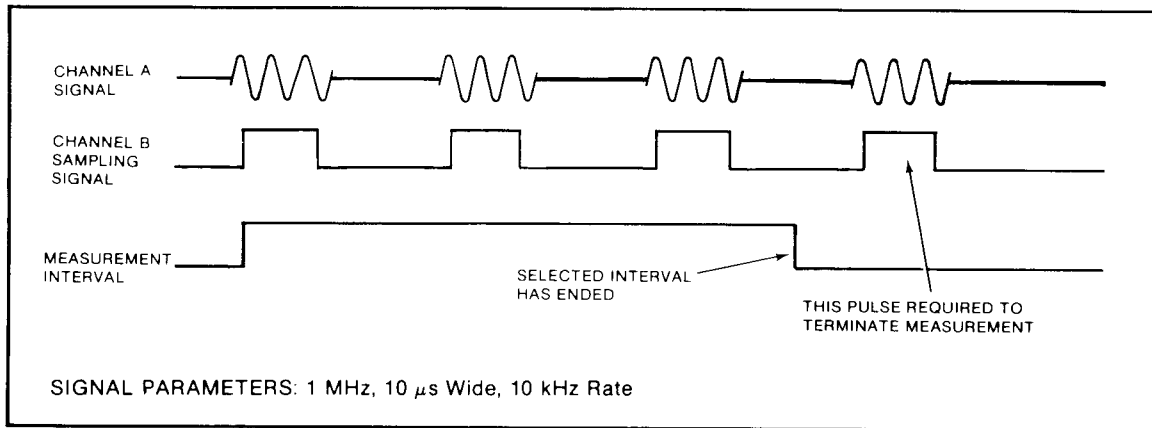

Figure 3-4. A ARMED BY B

3-25. The length of the measurement interval and signal repetition rate determine how many bursts will be averaged. Faster burst repetition rates allow shorter measurement intervals for a given number of averages. The main limit is that no more than 100 million “events” can be counted (either input signal cycles or time base counts). In the case of Figure 3-4, each burst contains 10 “events”, with 10 thousand occurring in 1 second for 100 thousand “events” per second. Since 100 million events is the limit, the 5315 could average for 1000 seconds before the events counter would overflow. And, since the measurement interval determines the number of averages, a 1000-second measurement interval would be necessary before the events count or time base count would overflow. This, of course, is longer than that obtainable from the 5315 (maximum measurement interval of about 10 seconds). A specific case where the 5315 would overflow would be a 50 MHz signal pulsed for 200 ns at a 2 MHz rate. In this case 10 “events” occur during each burst, with 2 million bursts per second, or 20 million “events” in 1-second. So, the 5315 would overflow in 5 seconds, thus the gate time must be less than 5 seconds, and 10 million bursts would be averaged. If the 100 million events limit is exceeded the displayed answer will be inaccurate.

3-26. A ARMED BY B has two modes (two different measurement interval ranges) and is not labeled on the front panel. For a measurement interval range of 500 μs-30 ms, press T.I. DELAY and RATIO A/B together. The measurement interval may be displayed by selecting the GATE TIME mode for the LONG interval or by pressing T.I. A→B, T.I. DELAY, and Blue Shift key simultaneously for the SHORT interval. For a measurement interval range of 60 ms to 10 seconds, press FREQ A and TOT STOP together. The Channel A Trigger Slope is set by the front panel Channel A Slope switch. The sampling signal enable slope (begin counting) is determined by the Blue Shift key. In the OUT position the counting will be enabled on the sampling signal positive slope. In the IN position, the counting will be enabled on the sampling signal negative slope. The gate will also be opened on the same slope as determined by the Blue Shift key. The disable slope is determined by the Channel B front panel slope switch. The measurement interval is controlled, as normal, by the front panel GATE TIME control. The gate will close once the selected time has passed. There is no problem if the gate should close in the middle of counting a burst. The following limits do exist in this mode:

1. 200 ns minimum dead time between bursts.
2. 100 ns minimum burst width.
3. The enable slope can only be negative when using the short measurement interval (500 μs-30 ms).

Resolution increases with the square root of the number of samples averaged, N.

$$\text{Resolution} \sim \frac{(10^{-7}) \times (\text{INPUT FREQ})}{(\text{Sampling Signal Width}) \times (\sqrt{N})} \text{ Hz}$$

$$N \sim \frac{\text{Measurement Interval}}{\text{Gate signal repetition rate}}$$

From *Figure 3-4*, the sampling signal is 10 μ s wide at a 10 kHz repetition rate with a measurement interval of 1-second. With a single-shot measurement:

$$\text{resolution} = \frac{100 \times 10^{-9}}{10 \times 10^{-6}} \times \frac{1 \times 10^6}{\sqrt{1}} = 10^4 \text{ or } 10 \text{ kHz resolution}$$

but with average N = 10000 (1 second measurement interval):

$$\text{resolution} = \frac{100 \times 10^{-9}}{10 \times 10^{-6}} \times \frac{10^6}{\sqrt{10000}} = 100 \text{ Hz (100 times better)}$$

Accuracy: The actual measurement interval is shorter than the correct value by about 1 nanosecond. With short sample pulse widths and large N values the displayed answer will not be perfectly accurate:

$$\text{Ultimate accuracy} = \frac{10^{-9}}{\text{measurement interval}} \times (\text{Input FREQ})$$

With a 10 μ s sample pulse width, accuracy can be as good as 100 Hz if enough events are averaged.

3-27. **FREQ C** (Frequency C Mode, Option 003)

3-28. To make a frequency measurement on a CW signal in the range of 50 MHz to 1 GHz, select FREQ C function and connect the signal to INPUT C.

NOTE

If the amplitude of the signal exceeds the 1V rms dynamic range, the measurement may be incorrect.

Set the GATE TIME control to MIN (but not hold). Set the SENS C control to MIN. Slowly move the SENS C control in a clockwise direction (toward MAX) until the counter begins to gate. This represents the optimum trigger sensitivity. To increase the displayed resolution, move the GATE TIME control toward MAX. Pressing either slope switch will reset the counter.

NOTE

The Trigger Lights for INPUT A and INPUT B are inoperative and extinguished when functions FREQ C or GATE TIME are selected. This is normal. However, pressing either Channel A or B Slope switches will reset the counter.

3-29. **TOT STOP/START** (Totalize Start-Stop Mode)

3-30. Totalize STOP/START is a manually gated, totalize mode of operation. Pressing the blue shift key (IN position) opens the main gate, allowing INPUT A events to be counted. Pressing the shift key again (OUT position) closes the gate, stopping the count. The count is continuously displayed, and cumulative from gate cycle to gate cycle. The RESET button clears the counter and resets the display to zero.

3-31. **CHECK** (Mode)

3-32. The Check mode applies 10 MHz from the internal (or external for 5315B) reference oscillator to the MRC. It is used to verify the basic operation of the counter, GATE light and GATE TIME control.

3-33. Display Check (Mode)

3-34. The Display Check mode is unlabeled; it cycles the display through a routine that exercises all digits and most annunciators. With the POWER switch to ON, and all function switches to the “OUT” position, a rolling display, corresponding to *Table 3-1*, will result.

Table 3-1. Display Check

All Displays	OVFL	ERROR	—	Hz	S	GATE	dp1	dp2	dp3
00000000 0							•		
11111111-1	•		•					•	
22222222 2	•				•				•
33333333-3	•		•		•				
44444444 4	•			•					
55555555-5	•	•	•	•					
66666666 6	•			•	•				
77777777-7	•		•	•	•				
88888888 8	•					•			
99999999-9	•		•			•			
BLANK	•		•	•	•	•			

3-35. FRONT AND REAR PANEL FEATURES AND CONTROLS

3-36. The following paragraphs describe the features and controls of the function selection, signal conditioning, and display sections of the front panel. Front and rear panel controls are individually located and described in *Figures 3-7* and *3-8*).

NOTE

Except RESET all front panel key switches “latch” in and stay when pushed. A second push releases latched keys. The six keys between RESET and the blue “shift” key are interconnected so that pushing one will release another latched key.

3-37. FUNCTION SELECTION CONTROLS

3-38. The function (mode) selection section of the front panel contains the POWER (Stby/On), Reset keys, Function Mode keys group (within the border outline), and Gate Time/Delay control.

3-39. The POWER key sets the 5315A/B either to ON or STBY (Standby). In the ON position (in power is supplied to entire instrument. In the STBY position (OUT) unregulated DC is supplied only to battery-pack charging circuits (Option 002). The RESET key clears and updates the display for continuous measurement modes, and resets the counter in totalize modes.

3-40. Each of the keys within the outlined function group can select one of two functions: With the blue shift key in the “OUT” position, the other six keys select the function labeled above (i.e., FREQ A, T.I. A→B, etc.). With the shift key in the “IN” position, the keys select the function labeled in blue below (i.e., PER A, T.I. AVG A→B, etc.).

3-41. The GATE TIME/DELAY control determines the amount of gate time per measurement, and it is continuously adjustable over a range of 50 ms to 10 seconds. The selected gate time may be displayed by pressing the GATE TIME function key, and the blue shift key. In the T.I. DELAY mode of operation the control determines the amount of time the Start Channel is held off or "delayed" (see paragraph 3-17). The amount of "delay" may be displayed by pressing the T.I. A→B, T.I. DELAY, and blue shift key simultaneously. In the T.I. A→B mode of operation, the GATE TIME/DELAY control determines the sample rate.

3-42. SIGNAL CONDITIONING CONTROLS

3-43. A full complement of signal conditioning controls are provided for each channel (A and B) input (see Figure 3-6). These controls allow the selection of Attenuation (X1, X20), Slope (positive or negative) and input coupling (AC or DC). The SEP/COM A switch allows the selection of separate Channel A and B inputs in the SEP position. The COM A position disconnects the Channel B Input BNC, and connects both Channel A and Channel B input amplifiers to the Channel A input.

3-44. A low pass filter for Channel A input is provided. With the FILTER NORM key "in" frequencies above 100 kHz are effectively attenuated. With the FILTER NORM key "out" there is no filtering.

3-45. TRIGGER LEVEL/SENSITIVITY CONTROLS

3-46. The Trigger Level/Sensitivity controls provided for each channel operate as follows: With the TRIGGER LEVEL/SENSITIVITY key "out", the LEVEL/SENS control adjusts the trigger level (over a range of ± 2.5 volts DC in ATTN X1, or ± 50 volt DC in ATTN X20). With the TRIGGER LEVEL/SENSITIVITY key "in", the LEVEL/SENS control adjusts the input sensitivity from MAX (10 mV up to 10 MHz, 25 mV up to 100 MHz) with control fully clockwise to MIN (greater than 500 mV) with control fully counterclockwise (see Figure 3-5).

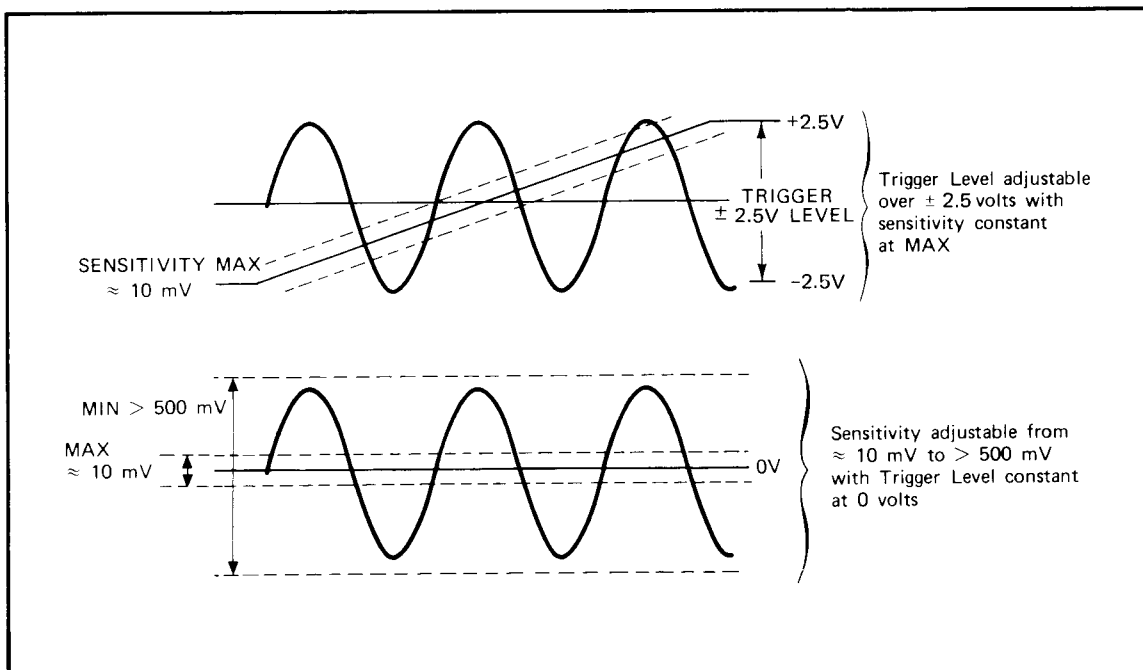

Figure 3-5. Trigger Level/Sensitivity Controls

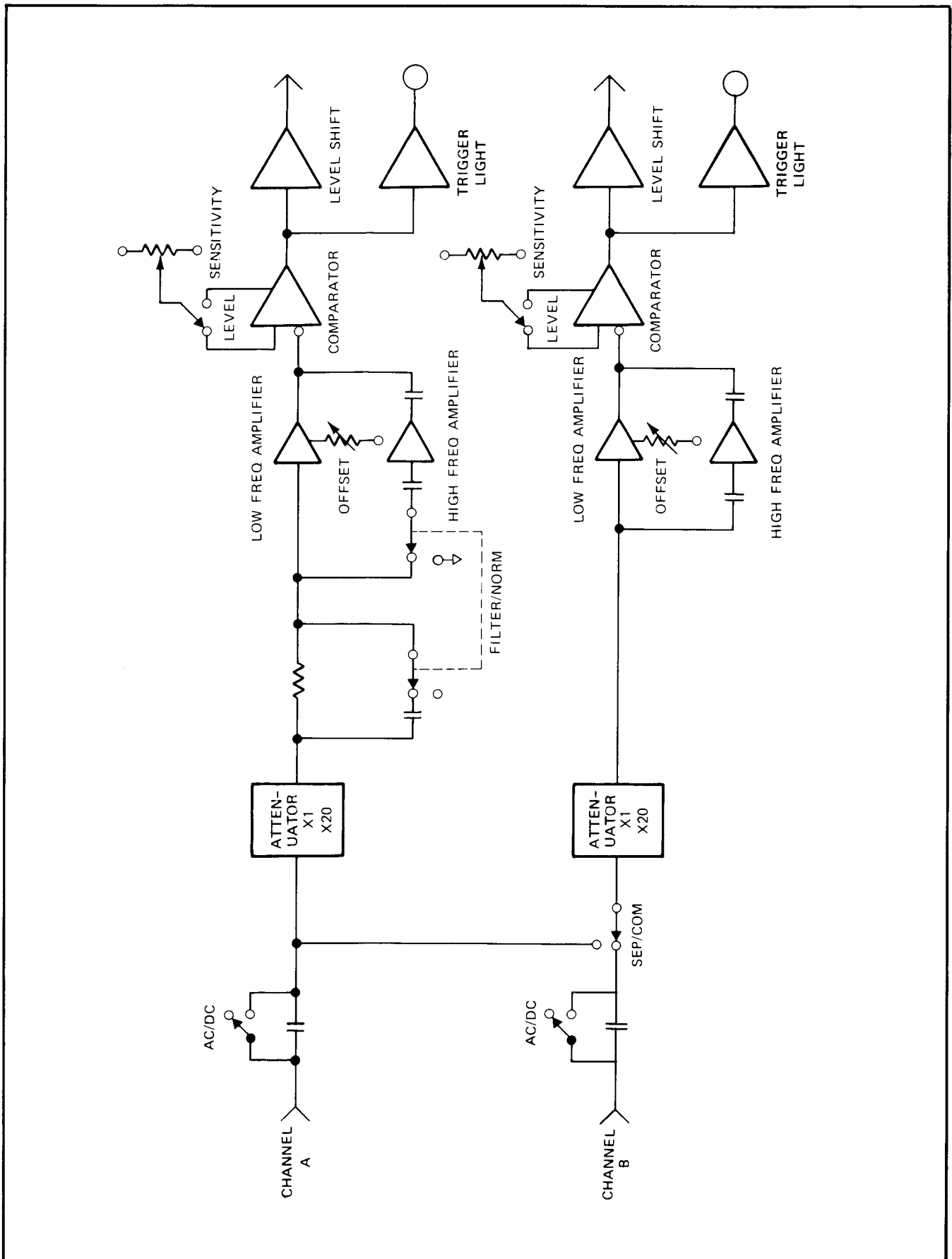
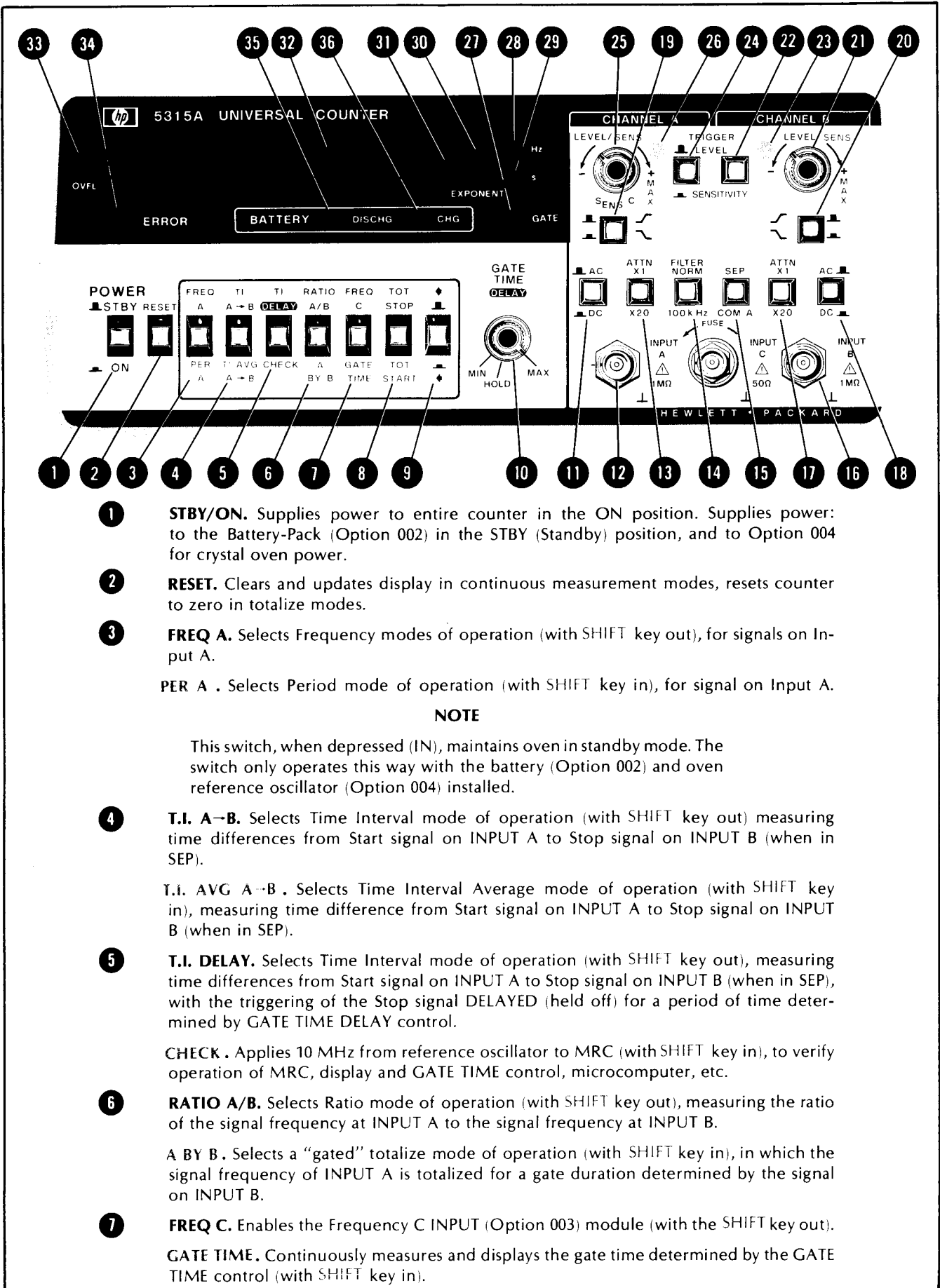

Figure 3-6. 5315A/B Front End Block Diagram



- 1 **STBY/ON.** Supplies power to entire counter in the ON position. Supplies power: to the Battery-Pack (Option 002) in the STBY (Standby) position, and to Option 004 for crystal oven power.
- 2 **RESET.** Clears and updates display in continuous measurement modes, resets counter to zero in totalize modes.
- 3 **FREQ A.** Selects Frequency modes of operation (with SHIFT key out), for signals on Input A.
PER A . Selects Period mode of operation (with SHIFT key in), for signal on Input A.

NOTE

This switch, when depressed (IN), maintains oven in standby mode. The switch only operates this way with the battery (Option 002) and oven reference oscillator (Option 004) installed.

- 4 **T.I. A-B.** Selects Time Interval mode of operation (with SHIFT key out) measuring time differences from Start signal on INPUT A to Stop signal on INPUT B (when in SEP).
T.I. AVG A-B . Selects Time Interval Average mode of operation (with SHIFT key in), measuring time difference from Start signal on INPUT A to Stop signal on INPUT B (when in SEP).
- 5 **T.I. DELAY.** Selects Time Interval mode of operation (with SHIFT key out), measuring time differences from Start signal on INPUT A to Stop signal on INPUT B (when in SEP), with the triggering of the Stop signal DELAYED (held off) for a period of time determined by GATE TIME DELAY control.
- 6 **CHECK .** Applies 10 MHz from reference oscillator to MRC (with SHIFT key in), to verify operation of MRC, display and GATE TIME control, microcomputer, etc.
- 7 **RATIO A/B.** Selects Ratio mode of operation (with SHIFT key out), measuring the ratio of the signal frequency at INPUT A to the signal frequency at INPUT B.
A BY B . Selects a "gated" totalize mode of operation (with SHIFT key in), in which the signal frequency of INPUT A is totalized for a gate duration determined by the signal on INPUT B.
- 7 **FREQ C.** Enables the Frequency C INPUT (Option 003) module (with the SHIFT key out).
GATE TIME. Continuously measures and displays the gate time determined by the GATE TIME control (with SHIFT key in).

Figure 3-7. Front Panel Features

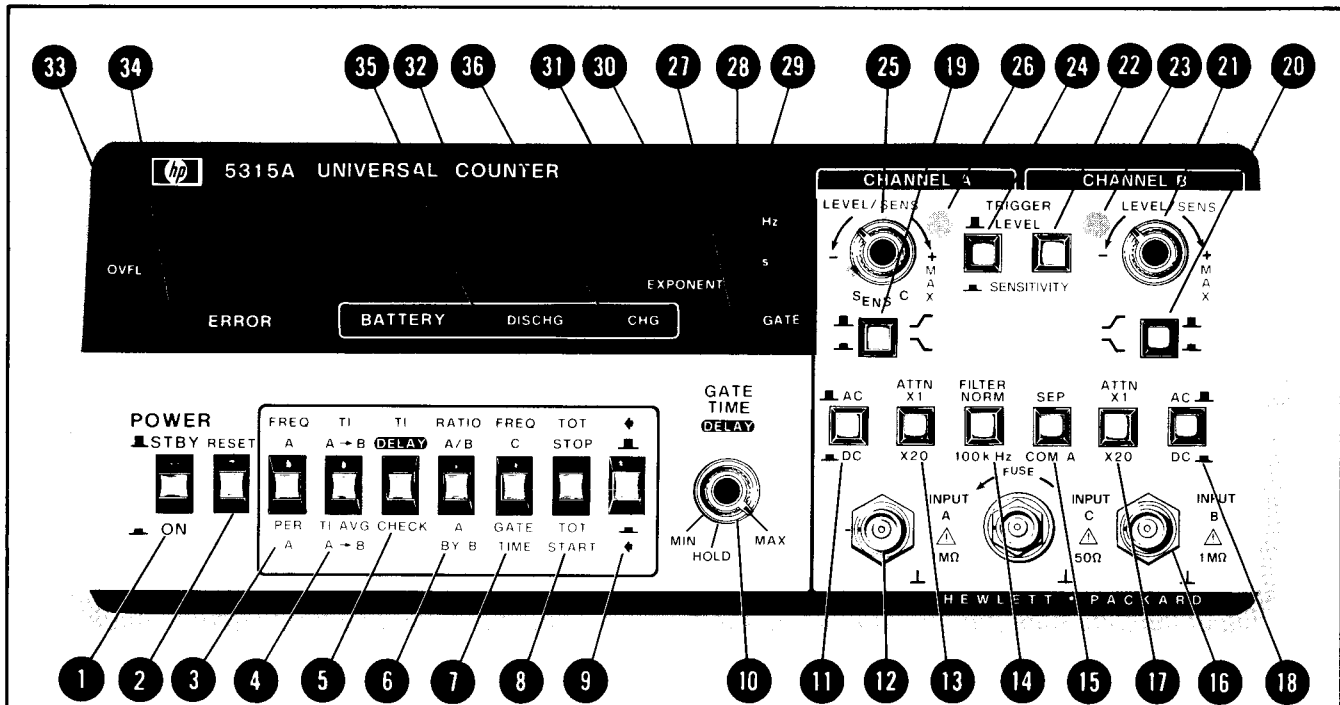

NOTE

The trigger lights are disabled and extinguished when either FREQ C or GATE TIME is selected.

- 8** **TOT, STOP/START.** Selects Totalize mode of operation, manually controlled by the SHIFT key. With the SHIFT key in, totalizing of signal frequency on INPUT A starts. With the SHIFT key out, totalized accumulation stops and holds. RESET must be pressed to zero the display.
- 9** **SHIFT.** Used in conjunction with six dual purpose function keys (3, 4, 5, 6, 7, 8) to select the function labeled above or below the key. With the SHIFT key out, functions labeled above the keys are enabled. With the SHIFT key in, functions labeled below the keys are enabled.
- 10** **GATE TIME/DELAY.** For FREQUENCY, PERIOD, RATIO AND T.I. AVERAGE modes, provides continuously variable measurement time from, nominally, 50 ms to 10 s (minimum = 1 period of the input signal). For T.I. mode, varies the time between measurements. For T.I. DELAY mode, provides continuously variable delay time between START and STOP enable.

HOLD. Single measurement with minimum gate time. Requires pushing RESET key to initiate new measurement.
- 11, 18** **AC/DC.** Selects AC or DC coupling for corresponding input signal except in the COM A mode. In the COM A mode, Channel A determines coupling.
- 12, 17** **INPUT A, B.** Input BNC's for channels A and B.
- 13, 16** **ATTN, X1/X20.** Selects attenuation of signal on corresponding input channels. X1 position connects input signal directly to input amplifiers; X20 position attenuates input signal by a factor of 20 (nominal).
- 14** **FILTER, NORM/100 kHz.** Inserts a low pass filter configuration into the INPUT A channel, attenuating frequencies above 100 kHz.
- 15** **SEP/COM A.** Input amplifier control, selects independent operation of Inputs A and B in SEP (separate) position. In COM A (Common A) position, the signal at Input A is also applied to Input B, with the B input BNC disconnected from input circuitry. Input B coupling is the same as Input A.

Figure 3-7. Front Panel Features (Continued)

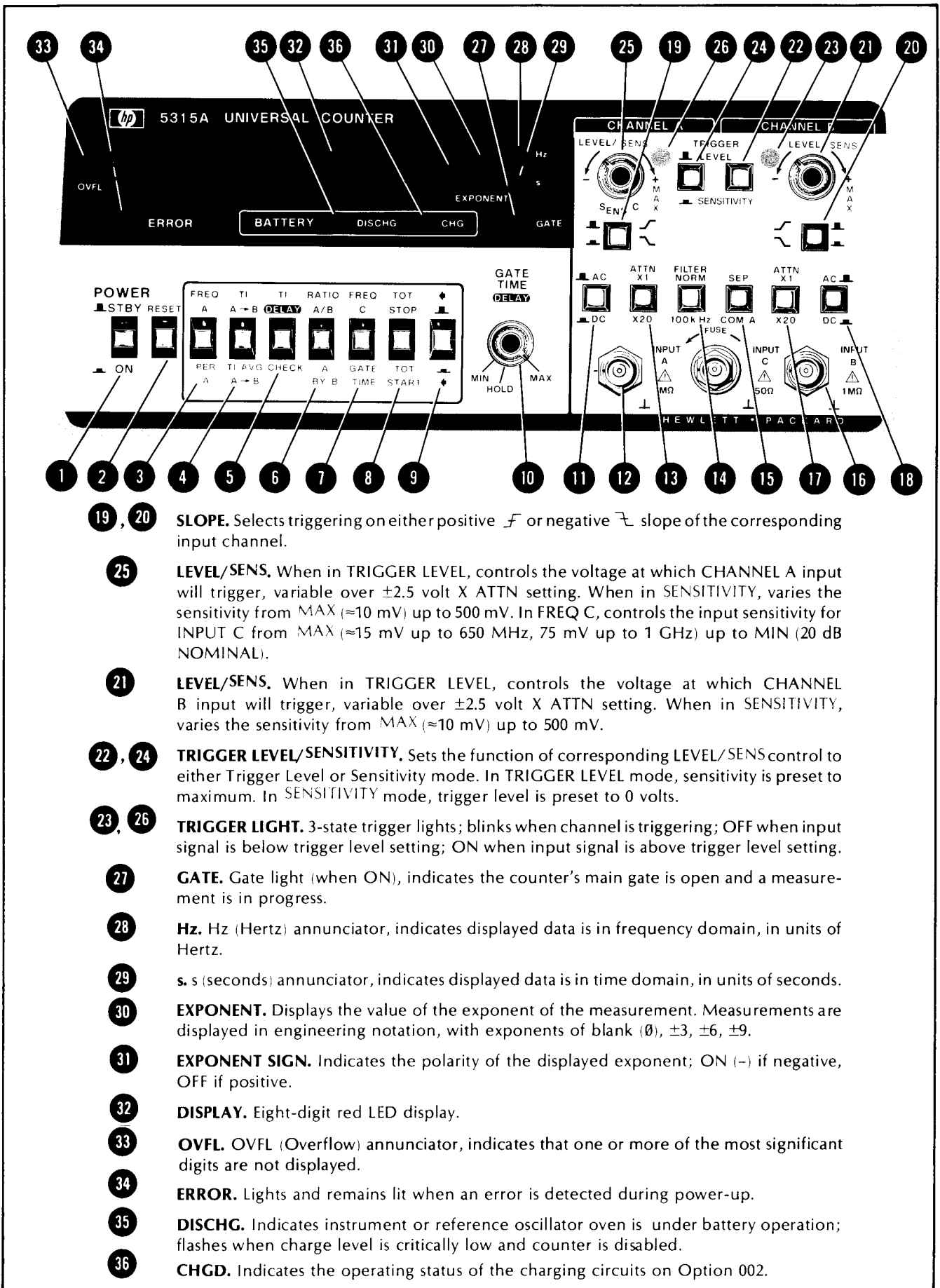

- 19, 20 **SLOPE.** Selects triggering on either positive \nearrow or negative \searrow slope of the corresponding input channel.
- 25 **LEVEL/SENS.** When in TRIGGER LEVEL, controls the voltage at which CHANNEL A input will trigger, variable over ± 2.5 volt X ATTN setting. When in SENSITIVITY, varies the sensitivity from MAX (≈ 10 mV) up to 500 mV. In FREQ C, controls the input sensitivity for INPUT C from MAX (≈ 15 mV up to 650 MHz, 75 mV up to 1 GHz) up to MIN (20 dB NOMINAL).
- 21 **LEVEL/SENS.** When in TRIGGER LEVEL, controls the voltage at which CHANNEL B input will trigger, variable over ± 2.5 volt X ATTN setting. When in SENSITIVITY, varies the sensitivity from MAX (≈ 10 mV) up to 500 mV.
- 22, 24 **TRIGGER LEVEL/SENSITIVITY.** Sets the function of corresponding LEVEL/SENS control to either Trigger Level or Sensitivity mode. In TRIGGER LEVEL mode, sensitivity is preset to maximum. In SENSITIVITY mode, trigger level is preset to 0 volts.
- 23, 26 **TRIGGER LIGHT.** 3-state trigger lights; blinks when channel is triggering; OFF when input signal is below trigger level setting; ON when input signal is above trigger level setting.
- 27 **GATE.** Gate light (when ON), indicates the counter's main gate is open and a measurement is in progress.
- 28 **Hz.** Hz (Hertz) annunciator, indicates displayed data is in frequency domain, in units of Hertz.
- 29 **s.** s (seconds) annunciator, indicates displayed data is in time domain, in units of seconds.
- 30 **EXPONENT.** Displays the value of the exponent of the measurement. Measurements are displayed in engineering notation, with exponents of blank (\emptyset), ± 3 , ± 6 , ± 9 .
- 31 **EXPONENT SIGN.** Indicates the polarity of the displayed exponent; ON (-) if negative, OFF if positive.
- 32 **DISPLAY.** Eight-digit red LED display.
- 33 **OVFL.** OVFL (Overflow) annunciator, indicates that one or more of the most significant digits are not displayed.
- 34 **ERROR.** Lights and remains lit when an error is detected during power-up.
- 35 **DISCHG.** Indicates instrument or reference oscillator oven is under battery operation; flashes when charge level is critically low and counter is disabled.
- 36 **CHGD.** Indicates the operating status of the charging circuits on Option 002.

Figure 3-7. Front Panel Features (Continued)

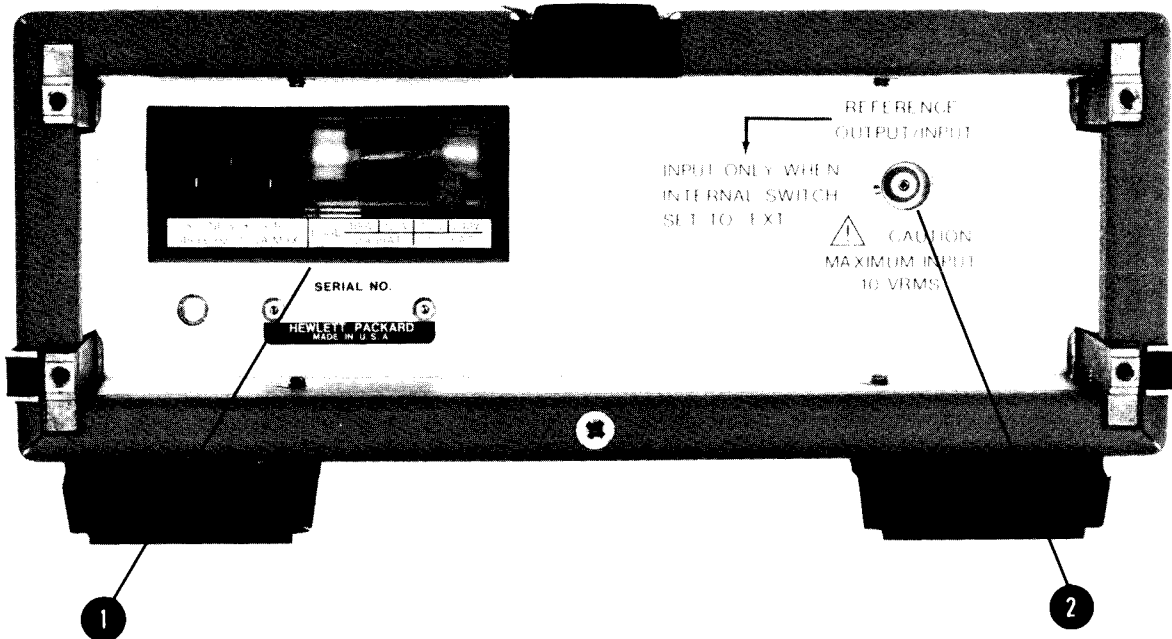

- 1 AC power input module permits operation from 100, 120, 220, or 240 volts AC. The number visible in the window indicates nominal line voltage to which instrument must be connected (see Figure 2-2). Protective grounding conductor connects to the instrument through this module.

WARNING

ANY INTERRUPTION OF THE PROTECTIVE (GROUNDING) CONDUCTOR INSIDE OR OUTSIDE THE INSTRUMENT OR DISCONNECTING OF THE PROTECTIVE EARTH TERMINAL IS LIKELY TO MAKE THE INSTRUMENT DANGEROUS. (See Section II.)

- 2 REFERENCE OUTPUT/INPUT jack (J8). Allows 5315B (only) to be operated with an external frequency standard of 10 MHz with drive of 1 volt rms across 500 Ω , when INT/EXT switch A1S3 (located on A1 Motherboard) is in the EXT position. With A1S3 in INT, the internal 10 MHz standard operates the counter, and is output for external use through J8.

Figure 3-8. 5315B Rear Panel Features

3-47. DISPLAY

3-48. The 5315A/B counter display has nine, seven-bar LED's, providing eight digits of resolution and a one-digit exponent. All measurements are displayed in scientific notation (i.e., exponents of blank, ± 3 , ± 6 , or ± 9) with automatic decimal point location. Annunciators for indicating the measurement units Hz, for Hertz, and s, for seconds are provided. The OVFL annunciator indicates that the left-most significant digits have overflowed the displayed. The GATE annunciator indicates the counter has been triggered and a measurement is in progress. The ERROR annunciator indicates a failure during power-up self-check. Battery annunciators DISCHG and CHG (on Models 5315A only) are active only when Option 002 is installed.

3-49. OPERATING INSTRUCTIONS

WARNING

BEFORE THE INSTRUMENT IS SWITCHED ON, ALL PROTECTIVE EARTH TERMINALS, EXTENSION CORDS, AUTOTRANSFORMERS, AND DEVICES CONNECTED TO IT SHOULD BE CONNECTED TO A PROTECTIVE EARTH GROUNDED SOCKET. ANY INTERRUPTION OF THE PROTECTIVE EARTH GROUNDING WILL CAUSE A POTENTIAL SHOCK HAZARD THAT COULD RESULT IN PERSONAL INJURY.

WARNING

ONLY FUSES WITH THE REQUIRED RATED CURRENT AND SPECIFIED TYPE SHOULD BE USED. DO NOT USE REPAIRED FUSES OR SHORT CIRCUITED FUSE-HOLDERS. TO DO SO COULD CAUSE A SHOCK OR FIRE HAZARD.

CAUTION

Before the instrument is turned on, it must be set to the voltage of the power source, or damage to the instrument could result.

3-50. OPERATOR'S CHECKS

3-51. A procedure for verifying the basic operation of the 5315A/B is provided in *Figure 3-9*. This check utilizes the instrument self-calibration cycle and visual verification of front panel controls by front panel indicators. No additional equipment is required.

NOTE

This check is not intended to verify the accuracy or performance specifications of the instrument.

3-52. POWER-UP SELF CHECK

3-53. When the 5315A/B is turned on, a power-up reset and self-check cycle is automatically initiated. This is approximately a 2-second cycle, indicated by the following display:

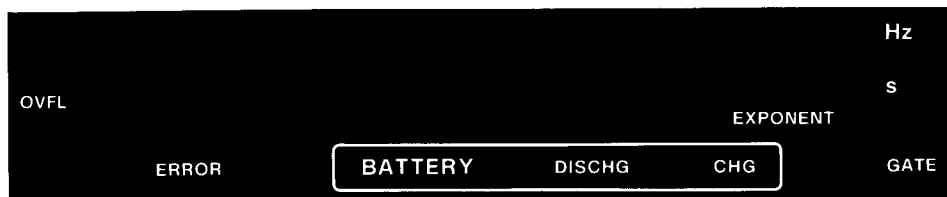

3-54. During this cycle, the microcomputer performs a check sum of the internal program in ROM and a bit pattern written into RAM. Additionally, a partial check of the MRC and I/O ports is performed. Any failure during the cycle will produce a numbered error message, momentarily displayed, and will latch the ERROR annunciator ON. Refer to Error Messages, paragraph 3-55.

NOTE

During the power-up self-check routine the ERROR state is undefined. Therefore, the ERROR annunciator may or may not be lit.

3-55. ERROR MESSAGES

3-56. Failures during the power-up self-check routine will result in a (momentary) display of a numbered error message. In addition, the ERROR annunciator will light and remain lit until the error is cleared and the instrument restarted. There are three numbered Error Messages:

ERROR	MESSAGE
E1	Possible Failure in Microcomputer
E2	Possible Failure in I/O Ports
E3	Possible Failure in MRC or No Oscillator Signal

3-57. If the ERROR annunciator is lit, verify the error number (1, 2, or 3) by repeating the power-up self-check, and refer to Section VIII, Troubleshooting. Power-up self-check is initiated when the POWER switch is changed from STBY to ON.

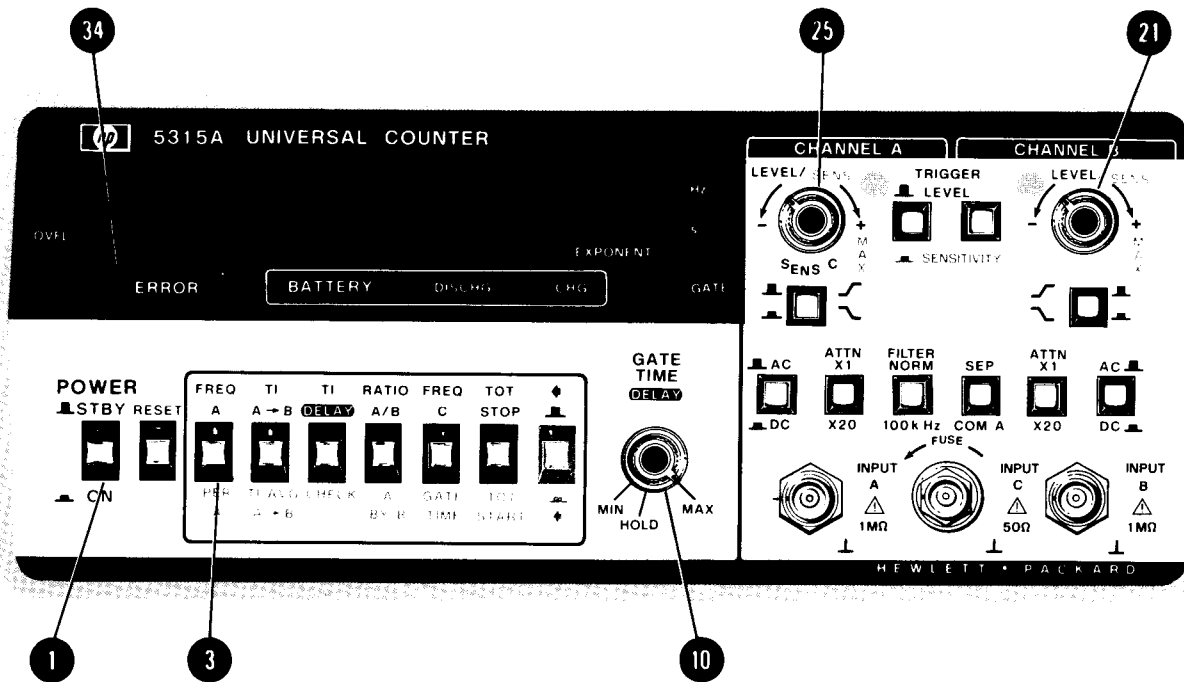

CAUTION

Before switching on the instrument, ensure that the power transformer primary is matched to the available line voltage, the correct fuse is installed and the safety precautions are taken. Refer to Power Requirements, Line Voltage Selection, Power Cables, and associated warnings and cautions in Section II of this manual.

1. Press FREQ A/PER A switch **3**, and adjust LEVEL/SENS controls **21** **25** fully ccw. Set all other switches to the OUT position.
2. Adjust GATE TIME control **10** to minimum.
3. Set POWER switch **1** to the ON position and observe the power-up self-check. Verify all segments of the display; decimal point after MSD; and the OVFL, Hz, S, and GATE annunciators light momentarily, followed by a display of 000. The ERROR annunciator may or may not light. Verify both trigger lights are lit.

NOTE

When the instrument is first turned on, the microcomputer performs a self-check. If, during power-up self-check, an error is detected, a numbered error message will flash momentarily and the Error annunciator **34** will light and remain lit. Verify the error number by repeating power-up self-check and refer to paragraph 3-59 Error Messages.

4. Verify Display Check routine by placing all function select switches in the OUT position. This may be accomplished by pressing any gray multi-function switch partially in, thereby releasing the function switch that is locked in. Observe the cycling of the display from all zero's to all one's, two's, three's . . . etc., to all blank. Refer to paragraph 3-33.

NOTE

The Display Check routine is an unlabeled function, used to verify the operation, digits and most annunciators within the Display assembly.

Figure 3-9. Operator's Check

3-58. MEASUREMENT PROCEDURES

3-59. Figures 3-13 through 3-21 show general operating procedures with the HP Model 5315A/B Universal Counter in typical measurement setups. Description numbers match the locator illustrations. The following paragraphs provide recommended operating guidelines to assist in making the most accurate measurement possible.

3-60. Frequency, Period, and Ratio Measurements

1. For cw sine wave or symmetrical waveforms (triangle, square, etc.) use AC coupling and the sensitivity mode.
2. For asymmetrical waveforms (pulse trains, TTL, ECL signals, ramps, etc.) use a combination of DC coupling, Trigger Level, and fixed attenuator. AC coupling these types of signals tends to distort them slightly, due to the charging of the capacitor. More important, the position of the signal on the zero preset trigger level is determined by the average DC level of the input. Depending on the pulse width and duty cycle, this DC average may be low enough to allow the base line noise to trigger the counter, producing extra counts (see Figure 3-10.) DC coupling fixes the DC level of the input signal, which allows the adjustable Trigger Level to be positioned at the optimum point. Set the Trigger Level control to the approximate center of the triggering range indicated by the trigger light (see Figure 3-11).

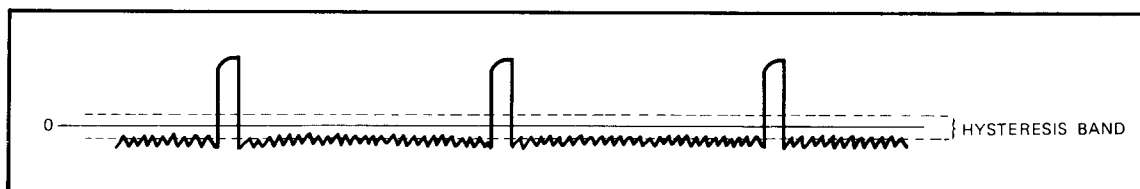

Figure 3-10. AC Coupled Measurements

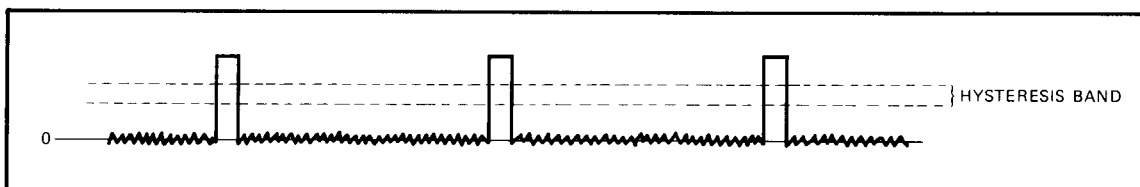

Figure 3-11. DC Coupled Measurements

3. When input loading is a problem (i.e., 1 M Ω load or cable capacitance) or when a more convenient method of probing is desirable, use a 10:1 Scope Probe. A probe is recommended for all logic applications.
4. For sine wave measurements 100 kHz and below, always use the low pass filter, selectable on the front panel. Normally the input signal is integrated over the entire 100 MHz bandwidth. Use of the filter effectively removes noise and harmonics (above 100 kHz) that may affect the correct measurement.

WARNING

WHEN MEASURING POWER LINE FREQUENCIES, BE EXTREMELY CAREFUL AND ALWAYS USE A STEP-DOWN ISOLATION TRANSFORMER (WITH ABOUT 10V OUTPUT). THE COUNTER'S PANEL IS TYPICALLY AT SIGNAL GROUND, SO NEVER TRY TO MEASURE THE 50 OR 60 Hz LINE WITHOUT AN ISOLATION TRANSFORMER.

5. Be very careful with input levels at higher frequencies (greater than 5 MHz). The counter front end can withstand only 6 volts rms at these frequencies.

3-61. Time Interval Measurements

1. To ensure waveform fidelity during T.I. measurements, always use DC coupling.
2. Measurements of pulse width, and time between pulses, are more conveniently made in the COM A (common) position.
3. Measuring extremely fast rise times is not recommended because of the difficulty of setting precise trigger levels.
4. T.I. Average measurements of synchronous frequencies (any 10 MHz, or harmonic of, with stability similar or better than the internal clock) are not recommended because of a possible lock-up condition.
5. In general, use the GATE TIME control to vary the amount of resolution displayed. This control does not affect accuracy. It basically trades off longer measurement time for more resolution.

3-62. OPTIONS

3-63. The operating characteristics of the 5315A/B are affected by the addition of any of the options described in the following paragraphs. Only one time base (Option 001 or 004) can be used in an instrument. The time base option replaces the standard time base.

3-64. Temperature Compensated Time Base OPTION 001

3-65. Option 001 provides a temperature-compensated-crystal-oscillator (TCXO) providing higher accuracy than the Standard Time base. The TCXO is a 10 MHz oscillator, capable of making minor frequency corrections to compensate for offsets due to temperature variations.

3-66. Battery and Charger OPTION 002

3-67. Option 002 provides for battery operation of HP Model 5315A. The option includes the battery, and circuitry required for recharging. The operation of the battery charger circuitry is monitored by front panel BATTERY indicators. See paragraph 8-79 for a complete description of battery operation and indicators. This option is available for Model 5315A only.

3-68. C Channel OPTION 003

3-69. Option 003 extends the frequency counting range of the 5315A/B from 100 MHz (in Channel A) to 1 GHz (in Channel C). The input sensitivity and gate time are adjustable by front panel controls. See *Table 1-1* for complete specifications of Option 003.

3-70. Oven Contained Time Base OPTION 004

3-71. Option 004 is an oven stabilized oscillator for the 5315A/B which results in greater measurement accuracy. The oven oscillator generates a higher stability 10 MHz signal over the full operating temperature range than achieved by a standard or Option 001 time base.

3-72. The 5315A Option 004 consumes less power than the 5315B Option 004 and is compatible with battery operation. The 5315B Option 004, however, offers the greatest accuracy. Option 004 is available only for HP Models 5315A/B having serial numbers prefixed 2120A and above.

3-73. Offset/Normalizer OPTION 006

3-74. Option 006 allows the operator to mathematically manipulate the 5315B display. Option 006 is described in its own installation and service manual, HP Part Number 05315-90011. This option is available for Model 5315B only.

3-75. OPERATOR'S MAINTENANCE

3-76. The only maintenance the operator should normally perform is the replacement of the primary power fuse on a standard 5315B. This fuse is located within the Line Module Assembly. For instructions on changing the fuse, refer to Section II, Line Voltage Selection.

CAUTION

Make sure that only fuses with the required rated current and of the slow-blow type are used for replacement. The use of repaired fuses and the short-circuiting of fuse-holders must be avoided.

3-77. When Option 003 C Channel is installed, the operator may be required to replace the input BNC fuse. This is a 1/8A fuse (HP Part No. 2110-0301) which is located within the INPUT C BNC connector (see *Figure 3-12.* for details). To replace the fuse, disconnect the power cord, unscrew the special BNC barrel (P/N 05305-60205) and, with needle-nose pliers, remove and replace the fuse. Reinstall the BNC barrel, and tighten using a BNC cable connector. Be careful not to overtighten.

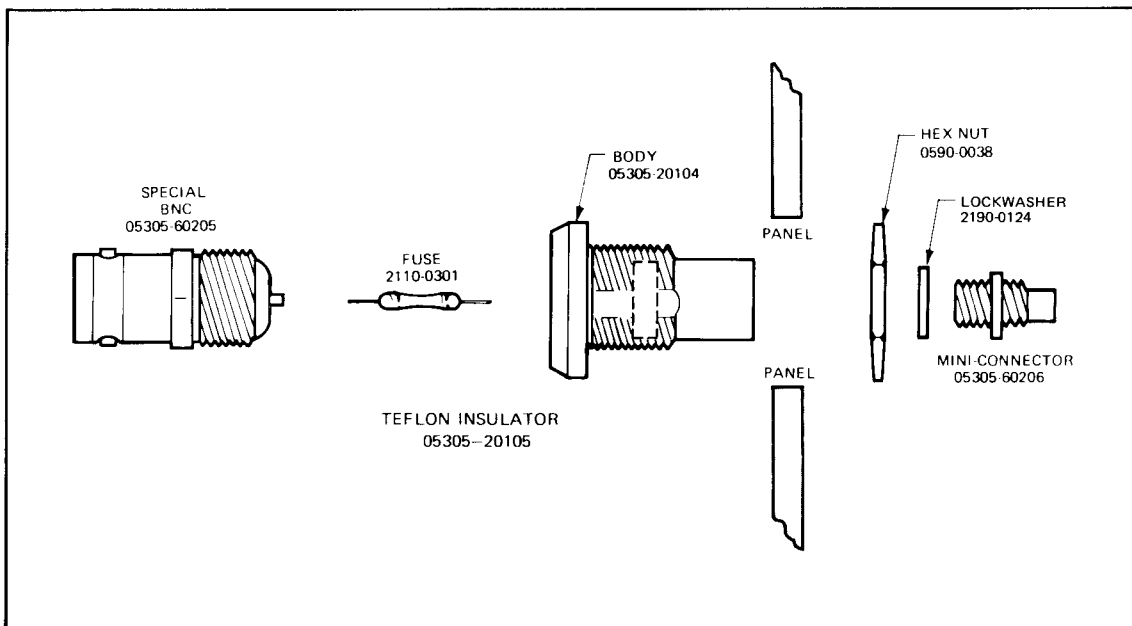

Figure 3-12. Details of Input Connector J1 and Fuse Mounting

3-78. POWER/WARM UP

3-79. The HP Model 5315A/B requires a power source of 100, 120, 220, or 240V AC, +5%, -10%, 48 to 66 Hz single phase. The selection of line voltage and input power fuse is described in Section II, paragraph 2-5, Preparation for Use.

3-80. The 5315A/B has a two-position power switch, STBY and ON. For 5315A models with Option 002, it is important that the instrument remain connected to the power source in the STBY mode when not in use. This supplies power to the battery charging circuitry.

WARNING

POWER IS ALWAYS PRESENT AT THE STBY/ON (LINE) SWITCH AND TRANSFORMER, AND UNREGULATED DC IS PRESENT WHENEVER THE LINE CORD IS ATTACHED. UNPLUGGING THE POWER CORD IS NECESSARY TO REMOVE ALL POWER FROM THE INSTRUMENT.

3-81. The Option 004 time base oven is supplied power whenever line (Mains) power is connected to the instrument. For a 5315A with both Options 002 and 004 installed, the oven receives standby power from the battery when the **FREQ A/PER A** switch is depressed.

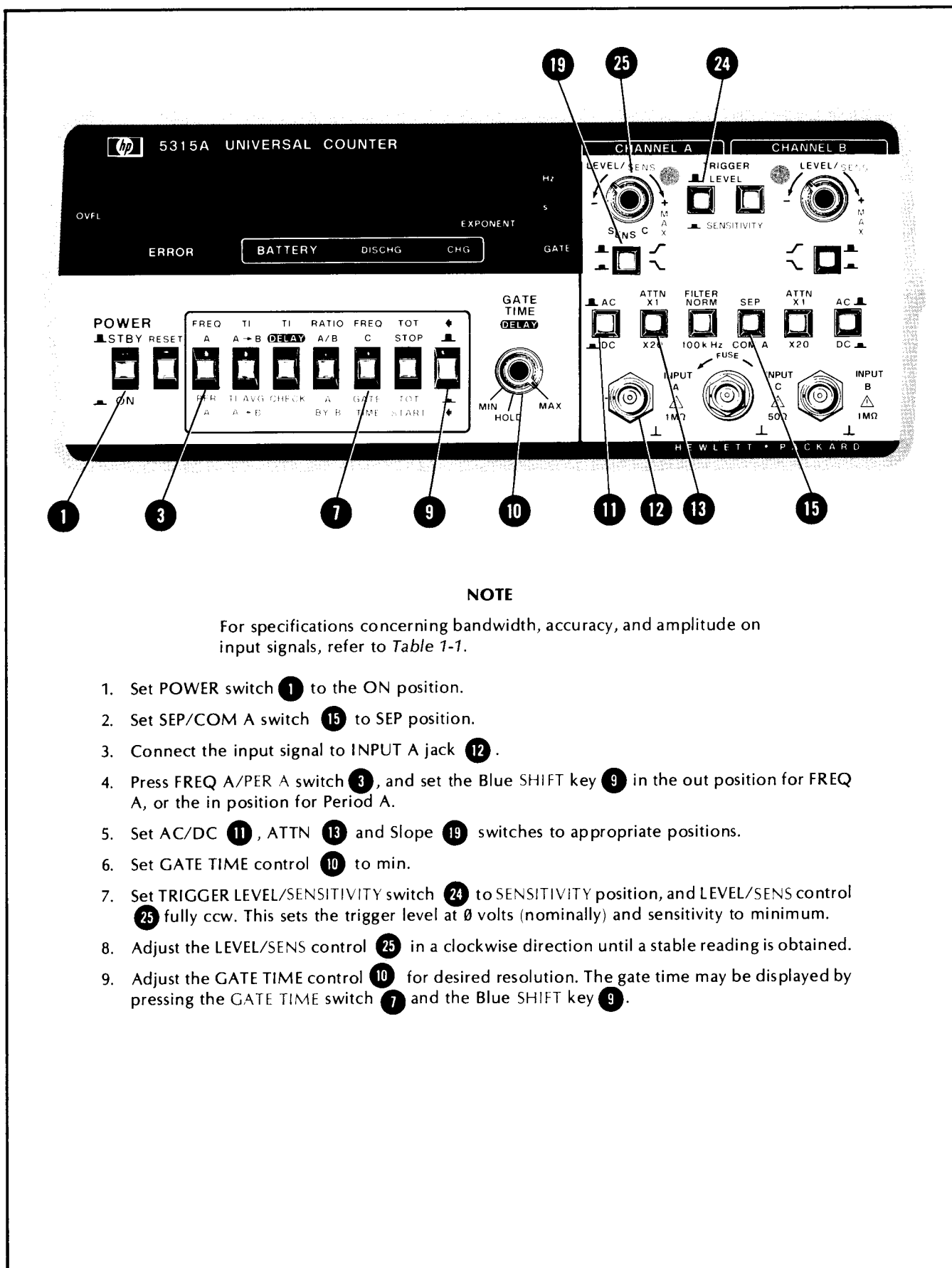

NOTE

For specifications concerning bandwidth, accuracy, and amplitude on input signals, refer to Table 1-1.

1. Set POWER switch **1** to the ON position.
2. Set SEP/COM A switch **15** to SEP position.
3. Connect the input signal to INPUT A jack **12**.
4. Press FREQ A/PER A switch **3**, and set the Blue SHIFT key **9** in the out position for FREQ A, or the in position for Period A.
5. Set AC/DC **11**, ATTN **13** and Slope **19** switches to appropriate positions.
6. Set GATE TIME control **10** to min.
7. Set TRIGGER LEVEL/SENSITIVITY switch **24** to SENSITIVITY position, and LEVEL/SENS control **25** fully ccw. This sets the trigger level at 0 volts (nominally) and sensitivity to minimum.
8. Adjust the LEVEL/SENS control **25** in a clockwise direction until a stable reading is obtained.
9. Adjust the GATE TIME control **10** for desired resolution. The gate time may be displayed by pressing the GATE TIME switch **7** and the Blue SHIFT key **9**.

Figure 3-13. Frequency A/Period A Measurements

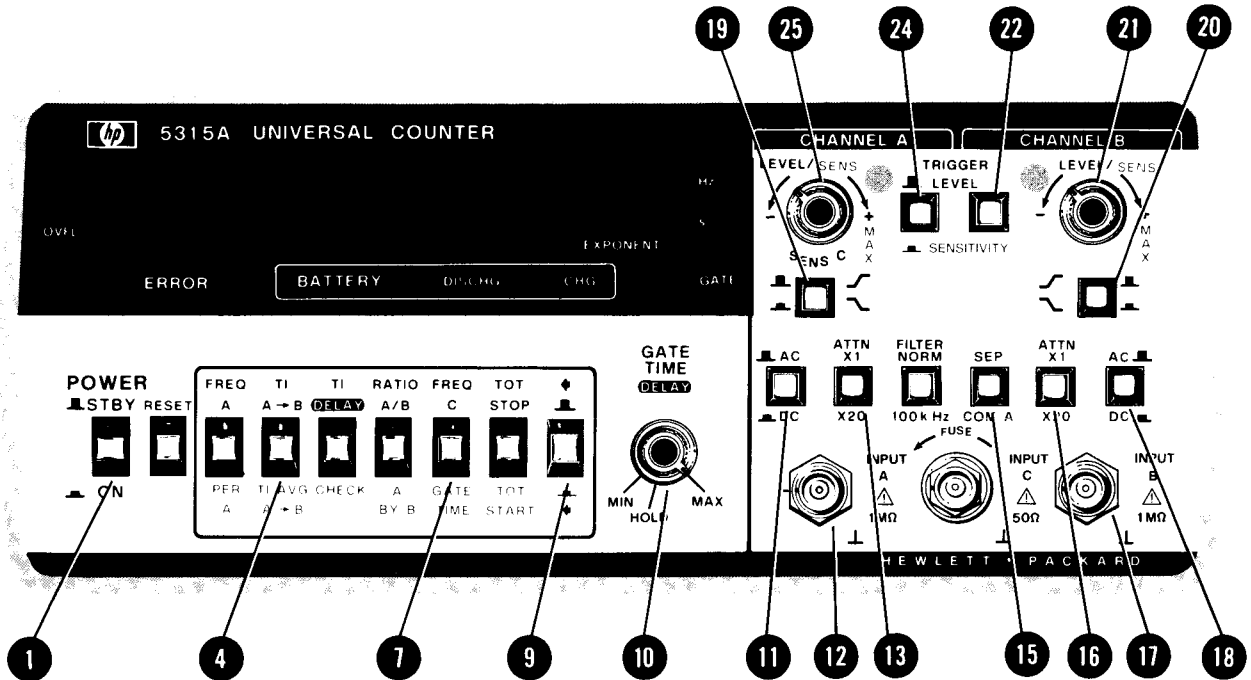

NOTE

For specifications concerning bandwidth, accuracy, and amplitude on input signals, refer to *Table 1-1*.

1. Set POWER switch **1** to the ON position.
2. Set GATE TIME control **10** to min.
3. If the Start and Stop signals are from separate sources, connect the Start signal to INPUT A jack **12**, the Stop signal to INPUT B jack **17**, and set the SEP/COM A switch **15** to SEP position. If the Start and Stop signals are from a common source, connect to INPUT A jack **12** and set the SEP/COM A switch **15** to COM A position.
4. Press T.I. A→B switch **4**, and ensure the Blue SHIFT key **9** is in the out position, to select time interval function.
5. Set AC/DC **11** **18**, ATTN **13** **16**, and Slope **19** **20** switches to desired positions.

NOTE

When the SEP/COM A switch is set to COM A, only the CHANNEL A AC/DC switch **11** is effective. However, all Attenuator, Slope, and LEVEL/SENS controls are effective.

6. Set TRIGGER LEVEL/SENSITIVITY switches **22** **24** to TRIGGER LEVEL position. This sets the sensitivity to maximum (typically ≤ 10 mV for frequencies ≤ 10 MHz) and allows variable selection of trigger levels.
7. Adjust the LEVEL/SENS controls **21** **25** for optimum triggering, usually the middle of the range over which the trigger light flashes.
8. Adjust the GATE TIME control **10** for the desired sample rate, variable nominally from 50 ms to 10 s. The selected gate time may be displayed by pressing the GATE TIME switch **7** and the Blue SHIFT key **9**.

NOTE

The first measurement is not displayed until the gate time delay is up. For slow sample rates, use HOLD and the RESET switch.

Figure 3-14. Time Interval Measurement

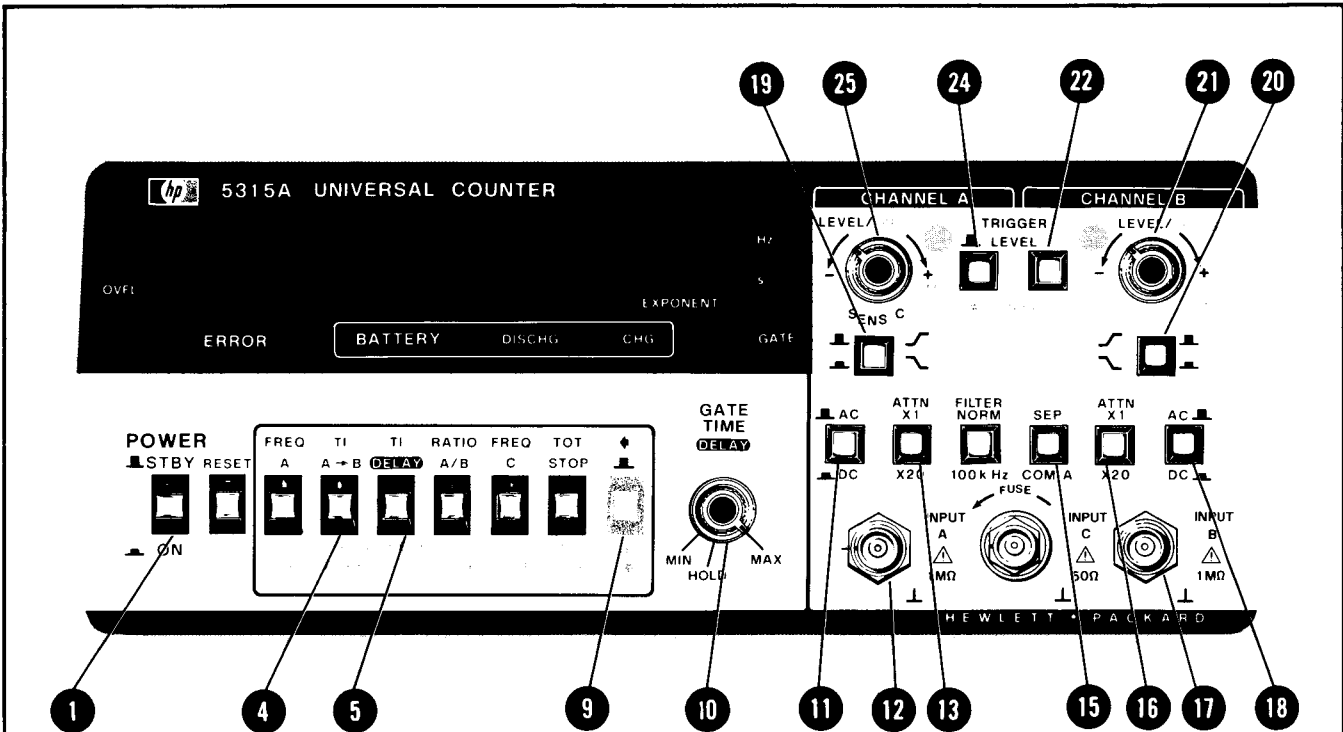

NOTE

For specifications concerning bandwidth, accuracy, and amplitude on input signals, refer to *Table 1-1*.

1. Set POWER switch **1** to the ON position.
2. If the Start and Stop signals are from separate sources, connect the Start signal to INPUT A jack **12**, the Stop signal to INPUT B jack **17**, and set the SEP/COM A switch **15** to SEP position. If the Start and Stop signals are from a common source, connect to INPUT A jack **12** and set the SEP/COM A switch **15** to COM A position.
3. Press T.I. DELAY switch **5**, and ensure the Blue key **9** is in the out position, to select time interval function.
4. Set AC/DC **11 18**, ATTN **13 16**, and Slope **19 20** switches to desired positions.

NOTE

When the SEP/COM A switch is set to COM A, only Channel A AC/DC switch **11** is effective. However, all ATTENUATOR, SLOPE, and LEVEL/SENS controls are effective.

5. Set TRIGGER LEVEL/SENS switches **22 24** to TRIGGER LEVEL position. This sets the sensitivity to maximum (typically ≤ 10 mV) and allows variable selection of trigger levels.
6. Adjust the LEVEL/SENS controls **21 25** for optimum triggering (i.e., the middle of the range over which the trigger light flashes).
7. Adjust the GATE TIME/DELAY control **10**, for the desired holdoff, (variable nominally from $500 \mu\text{s}$ to 20 ms) between the Start on Channel A and the enabling of Stop on Channel B. Inputs during the delay time are ignored. The selected delay time may be displayed by pressing T.I. A→B **4**, T.I. DELAY **5** and Blue key **9** to their in positions.

Figure 3-15. Time Interval Delay Measurement

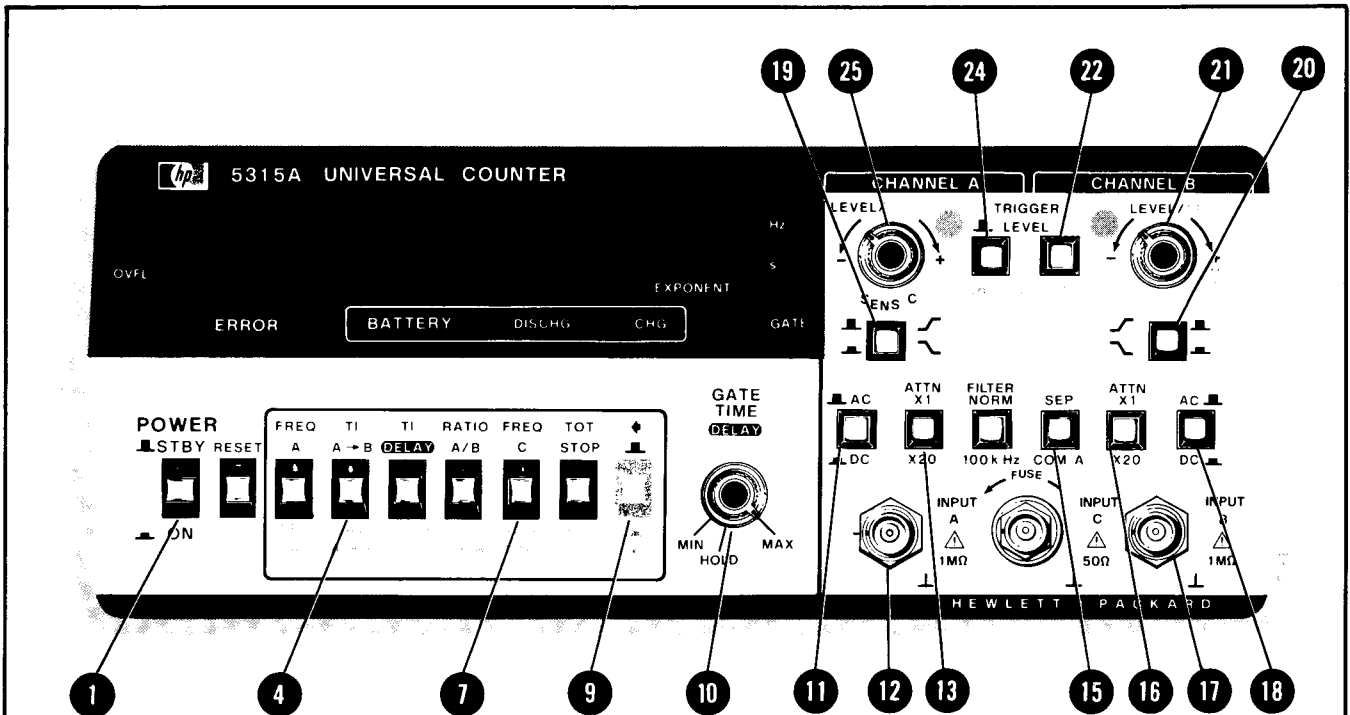

NOTE

For specifications concerning bandwidth, accuracy, and amplitude on input signals, refer to *Table 1-1*.

1. Set POWER switch **1** to the ON position.

NOTE

There must be at least 200 ns between the Stop pulse and the next Start pulse. When measuring the time interval between the same polarity slope of two pulses from a single source, the *Hold* mode should be used.

2. If the Start and Stop signals are from separate sources, connect the Start signal to INPUT A jack **12**, the Stop signal to INPUT B jack **17**, and set the SEP/COM A switch **15** to SEP position. If the Start and Stop signals are from a common source, connect to INPUT A jack **12** and set the SEP/COM A switch **15** to COM A position.
3. Press T.I. A→B switch **4**, and the Blue START key **9**, to select time interval average function.
4. Set AC/DC **11** **18**, ATTN **13** **16**, and Slope **19** **20** switches to desired positions.

NOTE

When the SEP/COM A switch is set to COM A, only the Channel A AC/DC switch **11** is effective. However, all ATTENUATOR, SLOPE, and LEVEL/SENS controls are effective.

5. Set TRIGGER LEVEL/SENS switches **22** **24** to TRIGGER LEVEL position. This sets the sensitivity to maximum (≤ 10 mV) and allows variable selection of trigger levels.
6. Adjust the LEVEL/SENS controls **21** **25** for optimum triggering (i.e., the middle of the range over which the trigger light flashes).
7. Adjust the GATE TIME control **10** for the desired resolution. The selected gate time may be displayed by setting the GATE TIME switch **7** and the Blue START key **9** to the "in" position.

NOTE

The T.I. Average A→B mode of operation will measure time intervals from 10^9 seconds down to 0 ns, with up to 1 ns resolution. A display of up to "- 1 or 2 ns, indicating a negative time interval is possible (i.e., Channel B event occurred before Channel A event).

Figure 3-16. Time Interval Average A→B

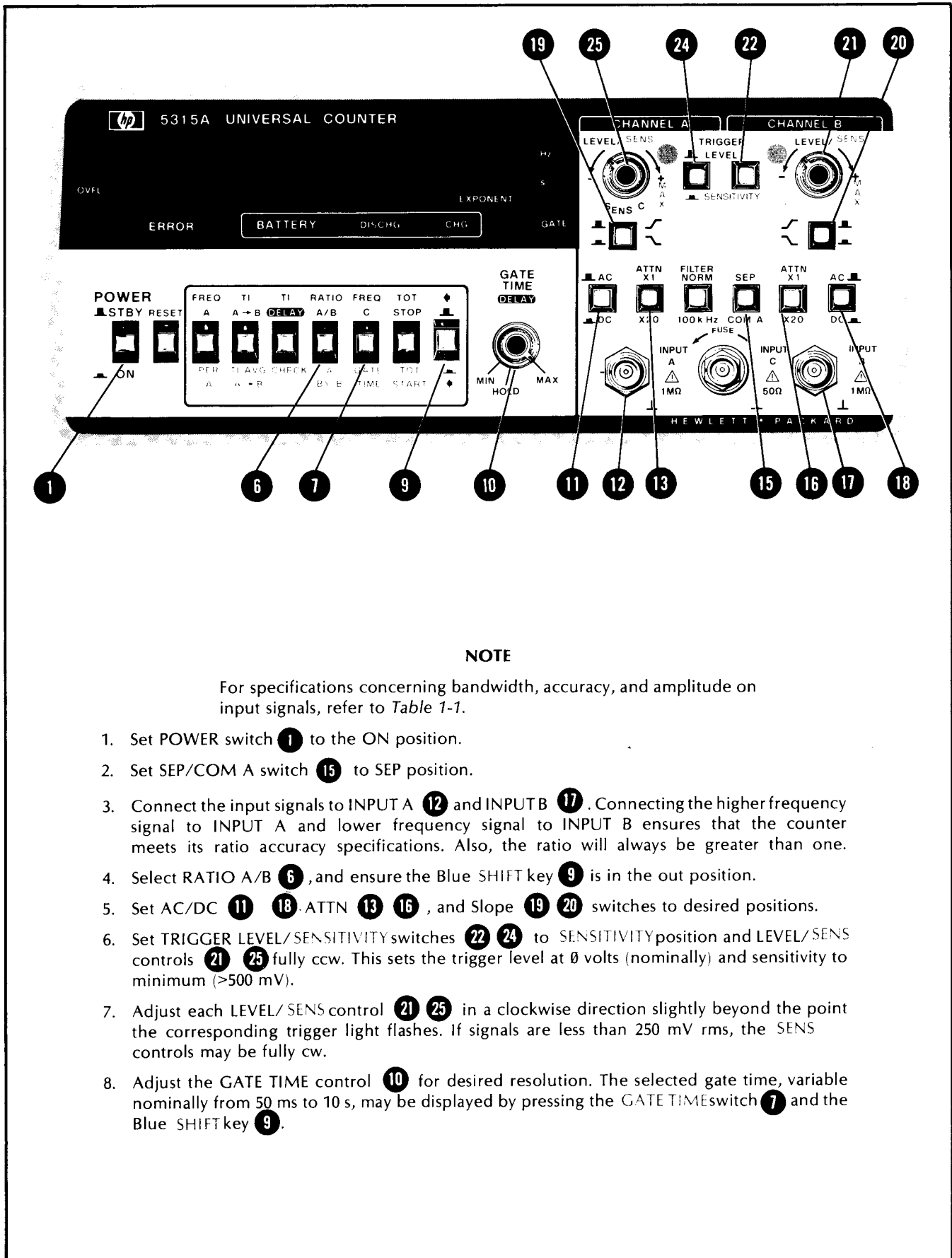

NOTE

For specifications concerning bandwidth, accuracy, and amplitude on input signals, refer to *Table 1-1*.

1. Set POWER switch **1** to the ON position.
2. Set SEP/COM A switch **15** to SEP position.
3. Connect the input signals to INPUT A **12** and INPUT B **17**. Connecting the higher frequency signal to INPUT A and lower frequency signal to INPUT B ensures that the counter meets its ratio accuracy specifications. Also, the ratio will always be greater than one.
4. Select RATIO A/B **6**, and ensure the Blue SHIFT key **9** is in the out position.
5. Set AC/DC **11** **18**, ATTN **13** **16**, and Slope **19** **20** switches to desired positions.
6. Set TRIGGER LEVEL/SENSITIVITY switches **22** **24** to SENSITIVITY position and LEVEL/SENS controls **21** **25** fully ccw. This sets the trigger level at 0 volts (nominally) and sensitivity to minimum (>500 mV).
7. Adjust each LEVEL/SENS control **21** **25** in a clockwise direction slightly beyond the point the corresponding trigger light flashes. If signals are less than 250 mV rms, the SENS controls may be fully cw.
8. Adjust the GATE TIME control **10** for desired resolution. The selected gate time, variable nominally from 50 ms to 10 s, may be displayed by pressing the GATE TIME switch **7** and the Blue SHIFT key **9**.

Figure 3-17. Ratio A/B Measurements

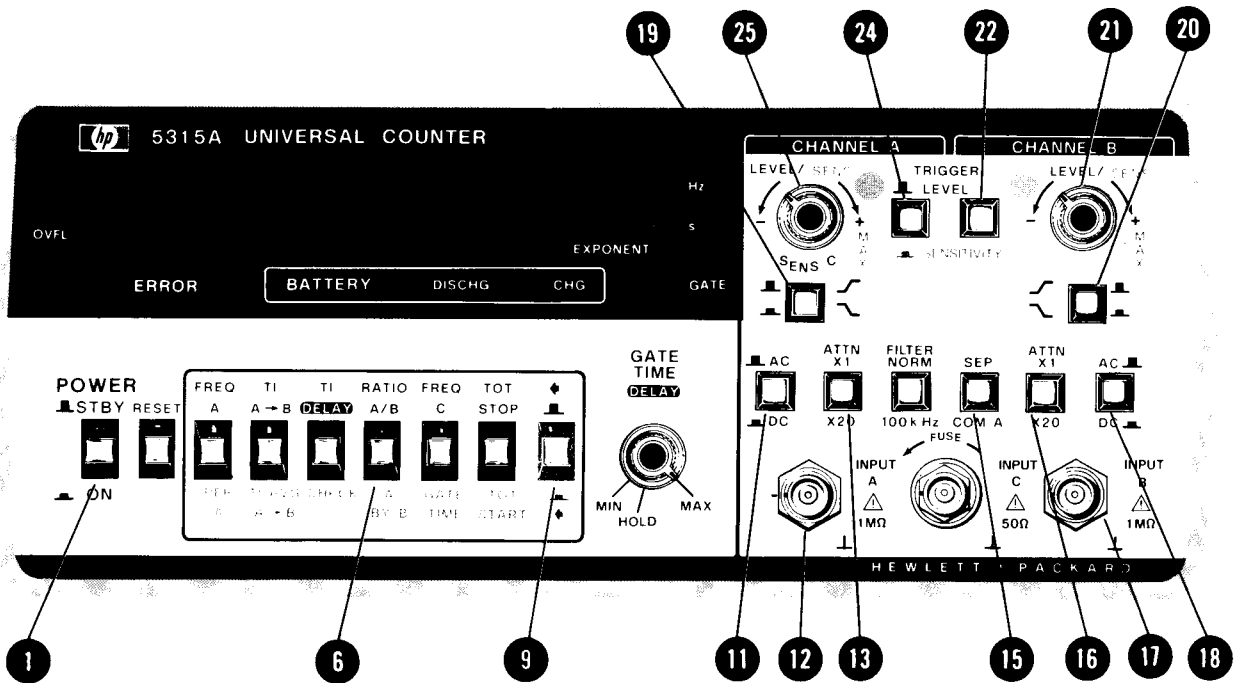

NOTE

For specifications concerning bandwidth, accuracy, and amplitude on input signals, refer to *Table 1-1*.

1. Set POWER switch **1** to the ON position.
2. Set SEP/COM A switch **15** to SEP position.
3. Connect the signal, either sine wave or pulses, to be totalized to INPUT A jack **12** and the gate control signal to INPUT B jack **17**.

NOTE

This mode will totalize inputs on Channel A for the time between two events on Channel B. The Gate will open on the A Slope setting and close on the B Slope setting. Reset is required to make a new measurement.

4. Press A BY B switch **6** and the Blue SHIFT key **9** to select the totalize A BY B function.
5. Set AC/DC **11 18**, ATTN **13 16** and Slope **19 20** switches to desired positions.
6. Set TRIGGER LEVEL/ SENSITIVITY switches **22 24** to SENSITIVITY position and LEVEL/ SENS **21 25** fully ccw. This sets the trigger level at 0 volts (nominally) and sensitivity to minimum (500 mV).
7. Adjust each LEVEL/ SENS **21 25** in a clockwise direction slightly beyond the point the corresponding trigger light flashes. If signals are less than 250 mV rms, the LEVEL/ SENS controls may be fully cw.
8. This function operates in a Single Shot mode. The RESET key must be pressed to initiate a new measurement.

Figure 3-18. A BY B Measurements

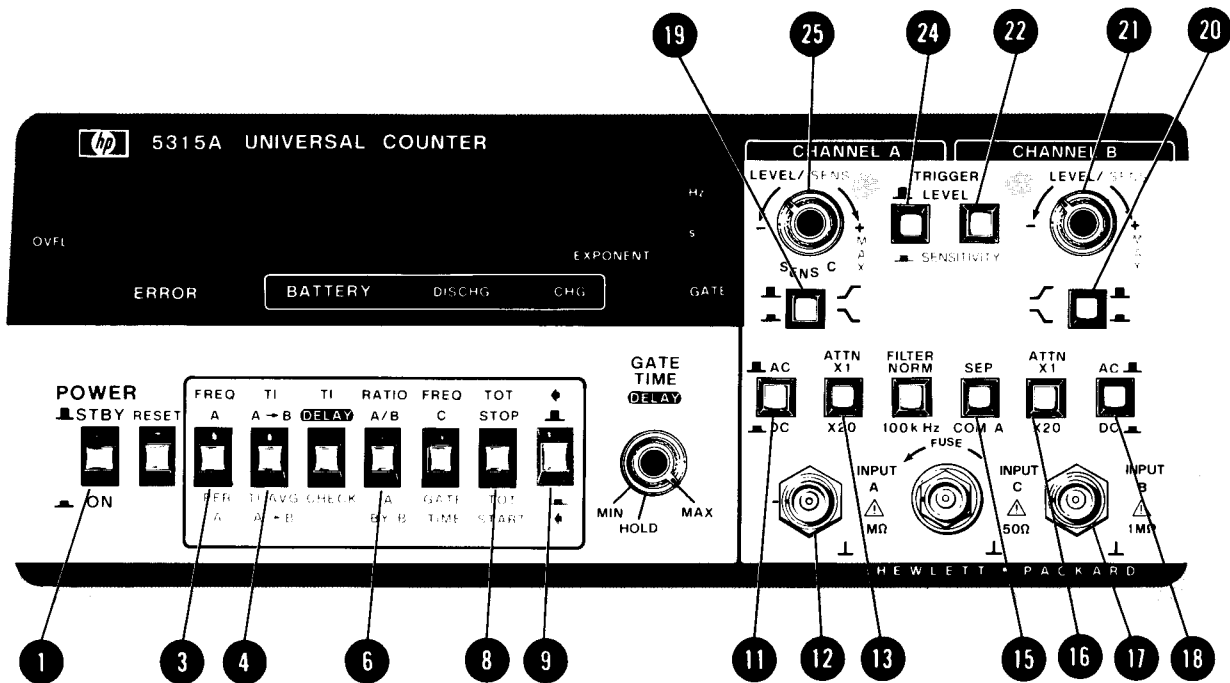

1. Set POWER switch **1** to the ON position.
2. Set SEP/COM A switch **15** to SEP position.
3. Connect the frequency burst signal to be averaged to INPUT A jack **12** and the sampling signal to INPUT B jack **17**. The sampling signal must be synchronized with, and of pulse width less than the burst.

NOTE

This mode will average together multiple frequency bursts and display the average frequency of the signal within the burst. *Due to the complexity of this function it is recommended that the user thoroughly read paragraph 3-23 before attempting to use this function.*

4. Press T.I. DELAY, CHECK switch **4** and RATIO A/B, A BY B switch **6** together for a gate time of 500 μ s-30 ms or FREQ A, PER A switch **3** and TOT STOP, TOT START switch **8** for a gate time of 60 ms-10 s.
5. Set AC/DC **11** **18**, ATTN **13** **16** to the desired positions.
6. Set the Blue Shift key **9** for the desired sampling/measurement interval enable slope: OUT for a positive enable slope, IN for a negative enable slope (negative slope only using SHORT measurement interval).
7. Set the A Channel SLOPE switch **19** to the desired trigger slope. Set the B Channel SLOPE switch **20** for the desired disable slope.
8. Set the TRIGGER/SENSITIVITY switches **22** **24** to SENSITIVITY position and LEVEL/SENS controls **21** **25** fully ccw. This sets the trigger level at 0 volts (nominally) and sensitivity to minimum (500 mV).
9. Adjust each LEVEL/SENS **21** **25** in a clockwise direction slightly beyond the point the corresponding trigger light flashes. If the signals are less than 250 mV, the LEVEL/SENS controls may be fully cw.

Figure 3-19. FREQ A Armed by B Measurements

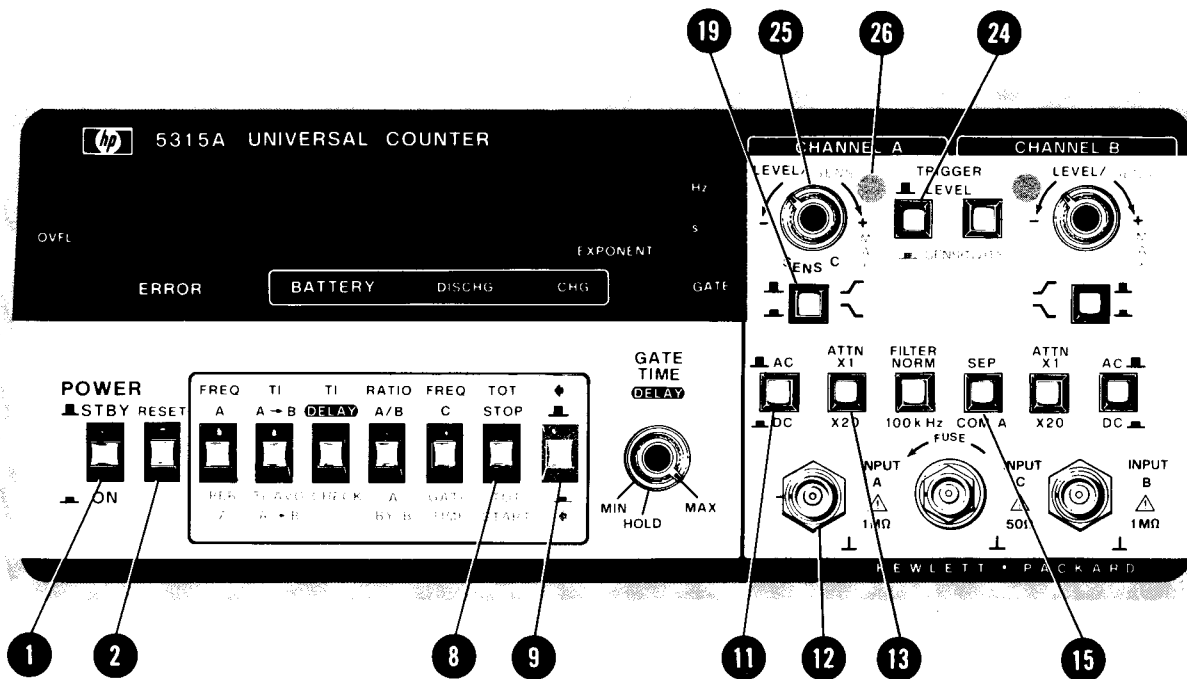

NOTE

For specifications concerning bandwidth, accuracy, and amplitude on input signals, refer to *Table 1-1*.

1. Set POWER switch **1** to the ON position.
2. Set SEP/COM A switch **15** to SEP position.
3. Connect the signal to be totalized to INPUT A jack **12**.

NOTE

This mode will totalize inputs on Channel A for the period of time manually selected on front panel switches.

4. Press TOT switch **8** and ensure the Blue SHIFT key **9** is in the out position.
5. Set AC/DC **11**, ATTN **13** and Slope **19** switches to desired positions.
6. Set TRIGGER LEVEL/SENSITIVITY switch **24** to SENSITIVITY position and LEVEL/SENS **25** fully ccw. This sets the trigger level at 0 volts (nominally) and sensitivity to minimum (500 mV).
7. Adjust the LEVEL/SENS control **25** in a clockwise direction slightly beyond the point the Channel A trigger light **26** flashes.
8. Press RESET **2** to clear display.
9. Press Blue SHIFT key **9** IN to START totalize measurement, and press again (out position) to STOP totalize. Repeat this procedure to accumulate count, press RESET **2** to clear display and enable a new measurement.

Figure 3-20. Totalize Measurement

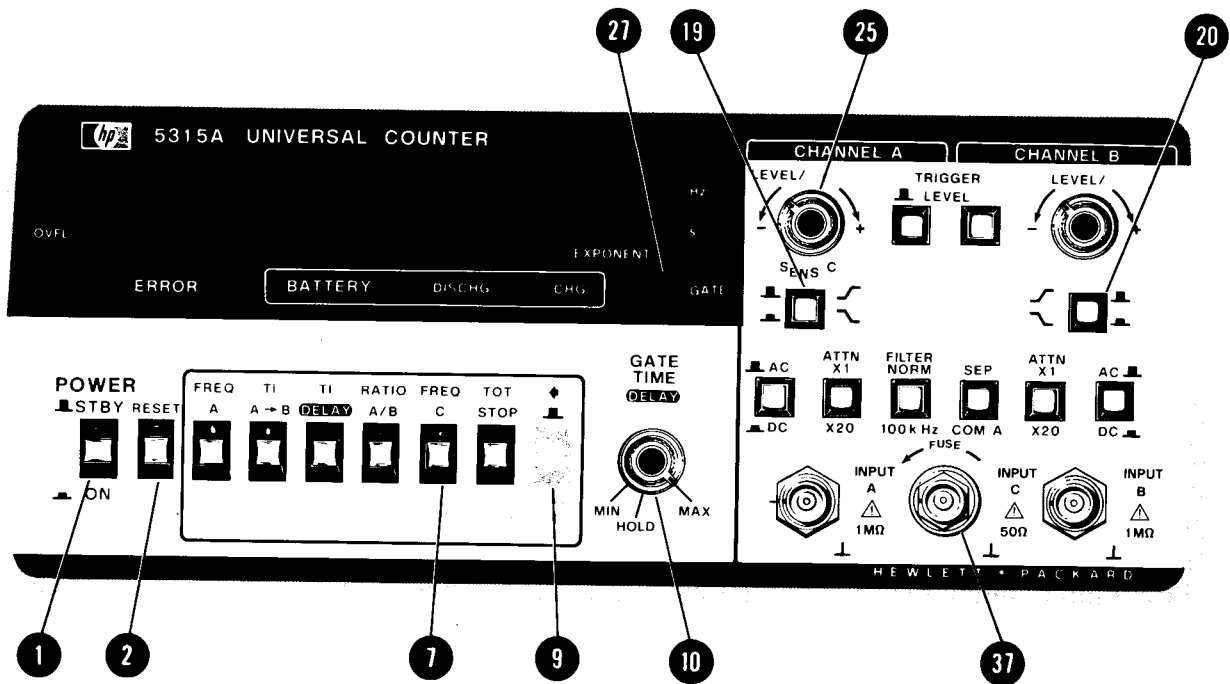

NOTE

For specifications concerning bandwidth, accuracy, and amplitude on input signals, refer to *Table 1-1*.

1. Set POWER switch (1) to ON position.
2. Set GATE TIME control (10) to MIN.
3. Select FREQ C and be sure that the blue SHIFT key is in the OUT position.

CAUTION

Be sure that the Input C signal does not exceed 1 V rms into 50 ohms.

4. Connect the input signal to INPUT C jack (37).

NOTE

The INPUT Connector is a special fused BNC. The in-line fuse within the connector is accessible from the front panel. Refer to the Operator's Maintenance section, paragraph 3-77, for replacement of fuse.

5. Set GATE TIME control (10) to min. Slowly rotate the control in a cw direction until the GATE light (27) just turns on.
6. Adjust the GATE TIME control (10) for the desired resolution. The actual gate time may be displayed by pressing the FREQ C function switch (7) and the Blue SHIFT key (9). Moving the GATE TIME control (10) fully ccw into detent will HOLD the measurement display. In HOLD, single-shot measurements with minimum gate time can be made by pressing the RESET (2) key.

NOTE

The only controls active in FREQ C function mode are GATE TIME (10), RESET (2), and SENS C (25). However, pressing either Channel A (19) or B (20) scope switches will reset the counter. All other controls have no effect.

Figure 3-21. Frequency C Measurement (Option 003)

SECTION IV PERFORMANCE TESTS

4-1. INTRODUCTION

4-2. The procedure in this section tests the electrical performance of the 5315A/B using the specifications in *Table 1-1* as the performance standards. The complete performance tests are given in *Tables 4-1* and *4-2*. All tests can be performed without access to the inside of the instrument.

4-3. Each test procedure found in this section is complete in itself. If the procedures are performed in order, any changes to the 5315A/B setup are printed in bold type. This makes it possible to do a single test out of sequence, yet the highest efficiency is achieved if all tests are performed.

4-4. OPERATIONAL VERIFICATION

4-5. The abbreviated checks given in *Table 4-1* can be performed to give a high degree of confidence that the 5315A/B is operating properly without performing the complete performance tests. The operational verification should be useful for incoming QA, routine maintenance, and after instrument repair. *Table 4-1* consists of the following:

- I. Self-Check
- II. Channel A Frequency Response/Sensitivity
- III. Channel B Frequency Response/Sensitivity and Ratio A/B
- IV. Time Interval and Time Interval Average
- V. Totalize

4-6. PERFORMANCE TESTS

4-7. The performance tests consist of all the tests given in this section as listed below and in *Table 4-2*. These tests verify the specifications in *Table 1-1*. All tests can be performed without access to the interior of the instrument.

- I. Display Test
- II. Self-Check
- III. Gate Time
- IV. Channel A Frequency Response/Sensitivity
- V. Channel B Frequency Response/Sensitivity and Ratio A/B
- VI. Period A
- VII. A By B
- VIII. Time Interval and Time Interval Average
- IX. Totalize
- X. Time Interval Delay
- XI. Channel C Frequency Response/Sensitivity

4-8. EQUIPMENT REQUIRED

4-9. Equipment required for the complete test and operational verification is listed in *Table 1-4*. Any equipment which satisfies the critical specification given in the table may be substituted for recommended model numbers.

4-10. TEST RECORD

4-11. Results of the operational verification and performance test may be tabulated on the test cards located at the end of each procedure.

Table 4-1. Operational Verification

The following tests will be performed:

- I. SELF-CHECK
- II. CHANNEL A FREQUENCY RESPONSE/SENSITIVITY
- III. CHANNEL B FREQUENCY RESPONSE/SENSITIVITY AND RATIO A/B
- IV. TIME INTERVAL AND TIME INTERVAL AVERAGE
- V. TOTALIZE

I. SELF-CHECK

- a. Set-Up:
 - POWER SWITCH ON (IN)
 - FUNCTION SELECT T.I. DELAY/CHECK
 - FUNCTION SET (Blue Shift Key) IN
- b. Verify the 5315A/B displays 10 MHz, with display resolution controlled by the Gate Time control knob. Resolution should increase with gate time.
- c. Record the results on the test card (PASS/FAIL).

II. CHANNEL A FREQUENCY RESPONSE/SENSITIVITY

- a. Specifications: 0.1 Hz to 100 MHz.
 - 1. 10 mV rms, sine wave 0.1 Hz–10 MHz, dc coupled.
 - 2. 10 mV rms, sine wave 30 Hz–10 MHz, ac coupled.
 - 3. 25 mV rms, sine wave 10–100 MHz, ac or dc coupled.
- b. Set-Up:
 - FUNCTION SELECT **FREQ A/PER A**
 - FUNCTION SET (Blue Shift Key) **OUT**
 - GATE TIME/DELAY control fully CCW, but not in HOLD
 - CHANNELS A&B TRIG LVL/SENS controls MAX (CW)
 - CHANNELS A&B TRIGGER LEVEL/SENSITIVITY SENS (IN)
 - CHANNELS A&B SLOPES POS (OUT)
 - CHANNELS A&B AC/DC DC (IN)
 - CHANNELS A&B ATTN X1/X20 X1 (OUT)
 - FILTER NORM/100 kHz FILTER NORM (OUT)
 - SEP/COM A SEP (OUT)
- c. Connect an HP 3325A Synthesizer/Function Generator, through a 50-ohm feedthrough, to the 5315A/B Channel A Input BNC connector.
- d. Set the HP 3325A for 1 Hz, then 10 MHz at 10 mV rms. Verify the 5315A/B displays correct frequencies.
- e. Replace the HP 3325A with an HP 8654A Signal Generator. Set the HP 8654A to 50 MHz and then 100 MHz at 25 mV rms. Verify the 5315A/B displays the correct frequencies.
- f. Record the results on the test card (PASS/FAIL).

III. CHANNEL B FREQUENCY RESPONSE/SENSITIVITY AND RATIO A/B

- a. Specifications: 0.1 Hz to 100 MHz.
 - 1. 10 mV rms, sine wave 0.1 Hz–10 MHz, dc coupled.
 - 2. 10 mV rms, sine wave 30 Hz–10 MHz, ac coupled.
 - 3. 25 mV rms, sine wave 10–100 MHz, ac or dc coupled.
- b. Set-Up:
 - FUNCTION SELECT **RATIO A/B — A BY B**
 - FUNCTION SET (Blue Shift Key) **OUT**
 - GATE TIME/DELAY control fully CCW, but not in HOLD
 - CHANNELS A&B TRIG LVL/SENS controls MAX (CW)
 - CHANNELS A&B TRIGGER LEVEL/SENSITIVITY SENS (IN)
 - CHANNELS A&B SLOPES POS (OUT)
 - CHANNEL A AC/DC** **AC (OUT)**
 - CHANNEL B AC/DC DC (IN)
 - CHANNELS A&B ATTN X1/X20 X1 (OUT)
 - FILTER NORM/100 kHz FILTER NORM (OUT)
 - SEP/COM A SEP (OUT)
- c. Connect an HP 3325A Synthesizer/Function Generator, through a 50-ohm feedthrough, to the 5315A/B Channel B Input BNC. Connect the HP 3325A front panel SYNC OUT, through a 50-ohm feedthrough, to the 5315A/B Channel A Input BNC.

Table 4-1. Operational Verification (Continued)

- d. Set the HP 3325A to 30 Hz at 10 mV rms. Verify the 5315A/B displays: 1.
- e. Set the HP 3325A to 10 MHz at 10 mV rms. Verify the 5315A/B displays: 1.000000.
- f. Replace the HP 3325A with an HP 8654A Signal Generator. Connect the HP 8654A front panel RF OUT, through a 50-ohm feedthrough, to the 5315A/B Channel B Input BNC. Connect the HP 8654A rear panel AUX OUTPUT, through a 50-ohm feedthrough, to the 5315A/B Channel A Input BNC.
- g. Set the HP 8654A to 100 MHz at 25 mV rms. The 5315A/B should have a stable display of: 1.0000000.
- h. Record the results on the test card (PASS/FAIL).

IV. TIME INTERVAL AND TIME INTERVAL AVERAGE

- a. Specifications:
 - 1. Time Interval 100 ns to 10⁵ seconds.
 - 2. Time Interval Average 0 ns to 10⁵ seconds.

- b. Set-Up:

FUNCTION SELECT **T.I. A-B/T.I. AVG A-B**
FUNCTION SET (Blue Shift Key) **OUT**
 GATE TIME/DELAY control fully CCW, but not in HOLD
 CHANNELS A&B TRIG LVL/SENS controls **MAX (CW)**
 CHANNELS A&B TRIGGER LEVEL/SENSITIVITY **SENS (IN)**
 CHANNEL A SLOPE **POS (OUT)**
CHANNEL B SLOPE **NEG (IN)**
CHANNEL A&B AC/DC **DC (IN)**
 CHANNEL A ATTN X1/X20 **X1 (OUT)**
 FILTER NORM/100 kHz **FILTER NORM (OUT)**
SEP/COM A **COM A (IN)**

- c. Connect an HP 3325A Synthesizer/Function Generator, through a 50-ohm feedthrough, to the 5315A/B Channel A Input BNC.
- d. Set the HP 3325A to 500.013 kHz square wave at 300 mV p-p. The 5315A/B display should read 1.0 E-6s ±1 count.
- e. Press Function Set (Blue Shift Key) IN. The 5315A/B display should read 1.000 E-6s ±5 ns.
- f. Change the Channel B Slope to Positive (OUT). The display should read either 2.000 E-6s ±5 ns or 0. E-9s ±5 ns.
- g. Change the Channel A Slope to Negative (IN). The 5315A/B display should read 1.000 E-6s ±5 ns.
- h. Change the Channel B Slope to Negative (IN). The 5315A/B display should read 0. E-9 ±5 ns or 2.000 E-6s ±5 ns.
- i. Record the results on the test card (PASS/FAIL).

V. TOTALIZE

- a. Specification: 0 to 100 MHz.
- b. Set-Up:

FUNCTION SELECT **TOT STOP/TOT START**
FUNCTION SET (Blue Shift Key) **OUT**
 GATE TIME/DELAY control fully CCW, but not in HOLD
 CHANNELS A&B TRIG LVL/SENS controls **MAX (CW)**
 CHANNELS A&B TRIGGER LEVEL/SENSITIVITY **SENS (IN)**
CHANNELS A&B SLOPES **POS (OUT)**
 CHANNELS A&B AC/DC **DC (IN)**
 CHANNELS A&B ATTN X1/X20 **X1 (OUT)**
 FILTER NORM/200 kHz **FILTER NORM (OUT)**
SEP/COM A **SEP (OUT)**

- c. Connect an HP 3325A Synthesizer/Function Generator, through a 50-ohm feedthrough, to the 5315A/B Channel A Input BNC.
- d. Set the HP 3325A to 1 Hz at 100 mV rms. The 5315A/B display should read 0.
- e. Press the Function Set (Blue Shift Key) IN. Verify the 5315A/B is counting at a 1-count/second rate. The trigger LED will also flash at this rate.
- f. Release the Function Set (Blue Shift Key). The 5315A/B should display the total number of pulses counted. The GATE light should be off.
- g. Record the results on the test card (PASS/FAIL).

OPERATIONAL VERIFICATION TEST CARD

HEWLETT-PACKARD MODEL 5315A/B Test Performed By _____
UNIVERSAL COUNTER

Serial Number _____ Date _____

DESCRIPTION	CHECK
I. SELF-CHECK	_____
II. CHANNEL A FREQUENCY RESPONSE/SENSITIVITY	_____
III. CHANNEL B FREQUENCY RESPONSE/SENSITIVITY/RATIO	_____
IV. TIME INTERVAL AND TIME INTERVAL AVERAGE	_____
V. TOTALIZE	_____

Table 4-2. 5315A/B In-Cabinet Performance Test

The following tests will be included:

- I. DISPLAY TEST
- II. SELF-CHECK
- III. GATE TIME
- IV. CHANNEL A FREQUENCY RESPONSE/SENSITIVITY
- V. CHANNEL B FREQUENCY RESPONSE/SENSITIVITY AND RATIO A/B
- VI. PERIOD A
- VII. A BY B
- VIII. TIME INTERVAL AND TIME INTERVAL AVERAGE
- IX. TOTALIZE
- X. TIME INTERVAL DELAY
- XI. CHANNEL C FREQUENCY RESPONSE/SENSITIVITY

I. DISPLAY TEST

- a. Turn the 5315A/B power ON. Place all FUNCTION SELECT switches in the OUT position, including the Function Set (Blue Shift Key).
- b. Refer to paragraph 3-33 and verify that rolling display is correct.
- c. Record the results on the test card (PASS/FAIL).

II. SELF-CHECK

- a. Set-Up:
 - FUNCTION SELECT T.I. DELAY/CHECK
 - FUNCTION SET (Blue Shift Key) IN
- b. Verify the 5315A/B displays 10 MHz, with display resolution controlled by the GATE TIME control knob. The resolution should increase with Gate Time.
- c. Record results on the test card (PASS/FAIL).

III. CHANNEL A FREQUENCY RESPONSE AND SENSITIVITY

- a. Specifications: 0.1 Hz to 100 MHz.
 - 1. 10 mV rms, sine wave 0.1 Hz-10 MHz, dc coupled.
 - 2. 10 mV rms, sine wave 30 Hz-10 MHz, ac coupled.
 - 3. 25 mV rms, sine wave 10-100 MHz, ac and dc coupled.
- b. Set-Up:
 - FUNCTION SELECT FREQ A/PER A
 - FUNCTION SET (Blue Shift Key) OUT
 - GATE TIME/DELAY control fully CCW, but not in HOLD
 - CHANNELS A&B TRIG LVL/SENS controls MAX (CW)
 - CHANNELS A&B TRIGGER LEVEL/SENSITIVITY SENS (IN)
 - CHANNELS A&B SLOPES POS (OUT)
 - CHANNELS A&B AC/DC DC (IN)
 - CHANNELS A&B ATTN X1/X20 X1 (OUT)
 - FILTER NORM/100 kHz FILTER NORM (OUT)
 - SEP/COM A SEP (OUT)
- c. Connect an HP 3325A Synthesizer/Function Generator, through a 50-ohm feedthrough, to the 5315A/B Channel A Input BNC.
- d. Set the HP 3325A to the following frequencies at 10 mV rms: 0.1 Hz, 10 Hz, 30 Hz, and 100 Hz.
- e. The 5315A/B should correctly display all frequencies in this range. (For the range of 0.1 Hz to 0.141 Hz, the OVFL light will be ON and the most significant digit "1" will not be displayed).
- f. Set the Channel A AC/DC switch to AC (OUT). While maintaining a 10 mV amplitude, set the 3325A to 30 Hz, 100 Hz, 500 kHz, and 10 MHz. Verify the 5315A/B displays the proper frequencies.
- g. Set the HP 3325A to 30 Hz at 5 mV rms. Increase the amplitude of the input signal until the 5315A/B displays a stable count of 30 Hz.
- h. Record on the test card the minimum amplitude at which the 5315A/B displays a stable count (VALUE).
- i. Set Channel A to DC coupled (IN).

Table 4-2. 5315A/B In-Cabinet Performance Test (Continued)

- j. Replace the 3325A with the HP 8654A Signal Generator. Set the 8654A to 50 MHz, 75 MHz, and 100 MHz. Maintain an amplitude of 25 mV rms. The 5315A/B should correctly display all frequencies in this range.
- k. Set the HP 8654A to 100 MHz to 5 mV rms. Increase the amplitude of the HP 8654A until the 5315A/B displays a stable count of 100 MHz.
- l. Record on the test card the minimum amplitude at which the 5315A/B displays a stable count (VALUE).

IV. CHANNEL B FREQUENCY RESPONSE/SENSITIVITY AND RATIO A/B

- a. Specifications: 0.1 Hz to 100 MHz.
 - 1. 10 mV rms, sine wave 0.1 Hz-10 MHz, dc coupled.
 - 2. 10 mV rms, sine wave 30 Hz-10 MHz, ac coupled.
 - 3. 25 mV rms, sine wave 10-100 MHz, ac and dc coupled.
- b. Set-Up:

FUNCTION SELECT **RATIO A/B — A BY B**
FUNCTION SET (Blue Shift Key) **OUT**
 GATE TIME/DELAY control fully CCW, but not in HOLD
 CHANNELS A&B TRIG LVL/SENS controls MAX (CW)
 CHANNELS A&B TRIGGER LEVEL/SENSITIVITY SENS (IN)
 CHANNELS A&B SLOPES POS (OUT)
 CHANNELS A&B AC/DC DC (IN)
 CHANNEL A ATTN X1/X20 X1 (OUT)
 FILTER NORM/100 kHz FILTER NORM (OUT)
 SEP/COM A SEP (OUT)

- c. Connect an HP 3325A Synthesizer/Function Generator, through a 50-ohm feedthrough to the 5315A/B Channel B Input BNC. Connect the HP 3325A front panel SYNC OUT, through a 50-ohm feedthrough, to the 5315A/B Channel A Input BNC.
- d. Set the HP 3325A to 10 Hz, 30 Hz, and 10 MHz at 10 mV rms. The 5315A/B should display a stable ratio of 1. to 1.000000 through the frequency range.
- e. Change Channel B to AC coupled (OUT). Maintaining the 10 mV rms amplitude, set the HP 3325A to 30 Hz, 100 Hz, 500 kHz, and 10 MHz. Verify the 5315A/B displays: 1. to 1.000000.
- f. Replace the HP 3325A with an HP 8654A Signal Generator. Connect the HP 8654A front panel RF OUT, through a 50-ohm feedthrough, to the 5315A/B Channel B input BNC. Connect the HP 8654A rear panel AUX OUT, through a 50-ohm feedthrough, to the 5315A/B Channel A Input BNC.
- g. Set Channel B to DC coupled (IN).
- h. While maintaining a 25 mV amplitude, set the HP 8654A to 50 MHz, 75 MHz, and 100 MHz. The 5315A/B should display a stable ratio from 1.000000 to 1.000000 throughout this frequency range.
- i. Record the results on the test card (PASS/FAIL).

V. PERIOD A

- a. Specification: 10 ns-10⁵ seconds.
- b. Set-Up:

FUNCTION SELECT **FREQ A/PER A**
FUNCTION SET (Blue Shift Key) **IN**
 GATE TIME/DELAY control fully CCW, but not in HOLD
 CHANNELS A&B TRIG LVL/SENS controls MAX (CW)
 CHANNELS A&B TRIGGER LEVEL/SENSITIVITY SENS (IN)
 CHANNELS A&B SLOPES POS (OUT)
CHANNELS A&B AC/DC **AC (OUT)**
 CHANNEL A ATTN X1/X20 X1 (OUT)
 FILTER NORM/100 kHz FILTER NORM (OUT)
 SEP/COM A SEP (OUT)

- c. Connect an HP 8654A to 5315A/B Channel A Input BNC with a 50-ohm feedthrough. Set the HP 8654A to 10 MHz and 100 MHz at 100 mV rms. The 5315A/B should display: 100 ns at 10 MHz and 10 ns at 100 MHz.
- d. Record the results on the test card (PASS/FAIL).

Table 4-2. 5315A/B In-Cabinet Performance Test (Continued)

VI. A BY B

a. Set-Up:

FUNCTION SELECT **RATIO A/B — A BY B**
FUNCTION SET (Blue Shift Key) **IN**
 GATE TIME/DELAY control fully CCW, but not in HOLD
 CHANNELS A&B TRIG LVL/SENS controls **MAX (CW)**
 CHANNELS A&B TRIGGER LEVEL/SENSITIVITY **SENS (IN)**
 CHANNELS A&B SLOPES **POS (OUT)**
CHANNELS A&B AC/DC **DC (IN)**
 CHANNELS A&B ATTN X1/X20 **X1 (OUT)**
 FILTER NORM/100 kHz **FILTER NORM (OUT)**
 SEP/COM A **SEP (OUT)**

- b. Connect the HP 3325A rear panel 1 MHz REF OUT, through a 50-ohm feedthrough to the Channel A Input BNC.
- c. Set the HP 3325A Synthesizer/Function Generator to 10 kHz square wave at 1.00 mV p-p. Connect the output of the HP 3325A to the CHANNEL B input BNC through a 50-ohm feedthrough.
- d. Verify the Channel A and B Trigger lights are flashing.
- e. Press the 5315A/B front panel RESET. The 5315A/B should display 100.000 ±1 count.
- f. Record the results on the test card (PASS/FAIL).

VII. TIME INTERVAL AND TIME INTERVAL AVERAGE

a. Specifications:

1. Time Interval: 100 ns to 10e5 seconds.
2. Time Interval Average: 0 ns to 10e5 seconds.

b. Set-Up:

FUNCTION SELECT **T.I. A-B/T.I. AVG A-B**
FUNCTION SET (Blue Shift Key) **OUT**
 GATE TIME/DELAY control fully CCW, but not in HOLD
 CHANNELS A&B TRIG LVL/SENS controls **MAX (CW)**
 CHANNELS A&B TRIGGER LEVEL/SENSITIVITY **SENS (IN)**
 CHANNEL A SLOPE **POS (OUT)**
CHANNEL B SLOPE **NEG (IN)**
 CHANNELS A&B AC/DC **DC (IN)**
 CHANNELS A&B FILTER NORM/100 kHz **FILTER NORM (OUT)**
SEP/COM A **COM A (IN)**

- c. Connect an HP 3325A Synthesizer/Function Generator, through a 50-ohm feedthrough, to the 5315A/B Channel A Input BNC.
- d. Set the HP 3325A to 500.013 kHz square wave at 300 mV p-p. The 5315A/B should display 1.0 E-6s ±1 count.
- e. Press Function Set (Blue Shift Key) IN. The 5315A/B should display 1.000 E-6s ±5 ns.
- f. Change the Channel B Slope to Positive (OUT). The 5315A/B should display either 2.000 E-6s ±5 ns or 0. E-9s ±5 ns.
- g. Change the Channel A Slope to Negative (IN). The 5315A/B should display 1.000 E-6s ±5 ns.
- h. Change the Channel B Slope to Negative (IN). The 5315A/B should display 0. E-9 ±5 ns, or 2.000 E-6s ±5 ns.
- i. Record the results on the test card (PASS/FAIL).

Table 4-2. 5315A/B In-Cabinet Performance Test (Continued)

VIII. TOTALIZE

- a. Specification: 0 to 100 MHz.
- b. Set-Up:

FUNCTION SELECT	TOT STOP/TOT START
FUNCTION SET (Blue Shift Key)	OUT
GATE TIME/DELAY control	fully CCW, but not in HOLD
CHANNELS A&B TRIG LVL/SENS controls	MAX (CW)
CHANNELS A&B TRIGGER LEVEL/SENSITIVITY	SENS (IN)
CHANNELS A&B SLOPES	POS (OUT)
CHANNELS A&B AC/DC	DC (IN)
CHANNELS A&B ATTN X1/X20	X1 (OUT)
FILTER NORM/100 kHz	FILTER NORM (OUT)
SEP/COM A	SEP (OUT)
- c. Connect an HP 3325A Synthesizer/Function Generator, through a 50-ohm feedthrough, to the 5315A/B Channel A Input BNC.
- d. Set the HP 3325A to 1 Hz at 100 mV rms. The 5315A/B should display 0.
- e. Press the Function Set (Blue Shift Key) IN. Verify the 5315A/B is counting at a 1 count/second rate. The trigger LED will also flash at this rate.
- f. Release the Function Set (Blue Shift Key) OUT. The 5315A/B should display the total number of pulses counted. The GATE light should be OFF.
- g. Record the results on the test card (PASS/FAIL).

IX. GATE TIME

- a. Set the Function Select to **FREQ C/GATE TIME**, and the Function Set (Blue Shift Key) IN. Vary Gate time pot from Min (CCW but not HOLD) to MAX (CW). The 5315A/B should display:
60 ms to 10 seconds nominal
- b. Set the Gate Time control to HOLD (detent). The 5315A/B should stop gating and hold the last measurement. The Gate Light should be OFF.
- c. Record the results on the test card (PASS/FAIL).

X. TIME INTERVAL DELAY

- a. Specification:

Variable delay: 500 μ s to 30 ms (nominal) between Channel A START and the enabling of Channel B STOP.
- b. Set-Up:

FUNCTION SELECT	T.I. DELAY/CHECK
FUNCTION SET (Blue Shift Key)	OUT
GATE TIME/DELAY control	fully CCW, but not in HOLD
CHANNELS A&B TRIG LVL/SENS	MAX (CW)
CHANNELS A&B TRIGGER LEVEL/SENSITIVITY	SENS (IN)
CHANNELS A&B AC/DC	AC (OUT)
CHANNEL A SLOPE	POS (OUT)
CHANNEL B SLOPE	NEG (IN)
FILTER NORM/100 kHz	FILTER NORM (OUT)
SEP/COM A	COM A (IN)
- c. Connect an HP 3325A Synthesizer/Function Generator, through a 50-ohm feedthrough, to the 5315A/B Channel A Input BNC.
- d. Set the HP 3325A to 250 Hz at 100 mV rms. Verify the Channels A and B Trigger Lights are flashing.
- e. The 5315A/B should display: 2 E-3.
- f. Slowly increase the GATE TIME control CW. The 5315A/B should jump from 2 E-3s to 6 E-3s and continue to increase in 4 ms steps to greater than 20 ms.
- g. Record the results on the test card (PASS/FAIL).

Table 4-2. 5315A/B In-Cabinet Performance Test (Continued)

XI. CHANNEL C FREQUENCY RESPONSE AND SENSITIVITY

- a. Specifications:
 - 1. 15 mV rms (-23.5 dBm), 50-650 MHz.
 - 2. 75 mV rms (-9.5 dBm), 650 MHz-1 GHz.
- b. Set the 5315A/B front panel controls as follows:
FUNCTION SELECT **FREQ C/GATE TIME (IN)**
FUNCTION SET (Blue Shift Key) (OUT)
GATE TIME/DELAY control **fully CCW, but not in HOLD**
CHANNEL A TRIGGER LVL/SENS C fully CW
- c. Connect the HP 8660C/86602A Synthesized Signal Generator, the HP 436A Power Meter, and the 5315A/B as shown in *Figure 4-1*.
- d. Set the HP 8660C Signal Generator to 50 MHz. Set output level for -23.5 dBm on the HP 436A Power Meter. Verify the 5315A/B gates and displays the 50 MHz. Repeat for 150 MHz, 350 MHz, and 650 MHz.
- e. Increase the HP 8660C/86602A output level for -9.5 dBm on the HP 436A Power Meter. Verify the 5315A/B gates and displays the proper frequency. Repeat for 900 MHz and 1000 MHz.
- f. Record the results on the test card (PASS/FAIL).

PERFORMANCE TEST CARD

HEWLETT-PACKARD MODEL 5315A/B
UNIVERSAL COUNTER

Test Performed By _____

Serial Number _____

Date _____

DESCRIPTION	CHECK
I. DISPLAY TEST (PASS/FAIL)	_____
II. SELF CHECK (PASS/FAIL)	_____
III. CHANNEL A FREQUENCY RESPONSE AND SENSITIVITY	
30 Hz-10 mV sensitivity specification (VALUE)	_____
100 MHz-10 mV sensitivity specification (VALUE)	_____
IV. CHANNEL B FREQUENCY RESPONSE/SENSITIVITY AND RATIO A/B (PASS/FAIL)	_____
V. PERIOD A (PASS/FAIL)	_____
VI. A BY B (PASS/FAIL)	_____
VII. TIME INTERVAL AND TIME INTERVAL AVERAGE (PASS/FAIL)	_____
VIII. TOTALIZE (PASS/FAIL)	_____
IX. GATE TIME (PASS/FAIL)	_____
X. TIME INTERVAL DELAY (PASS/FAIL)	_____
XI. CHANNEL C FREQUENCY RESPONSE/SENSITIVITY (PASS/FAIL)	_____

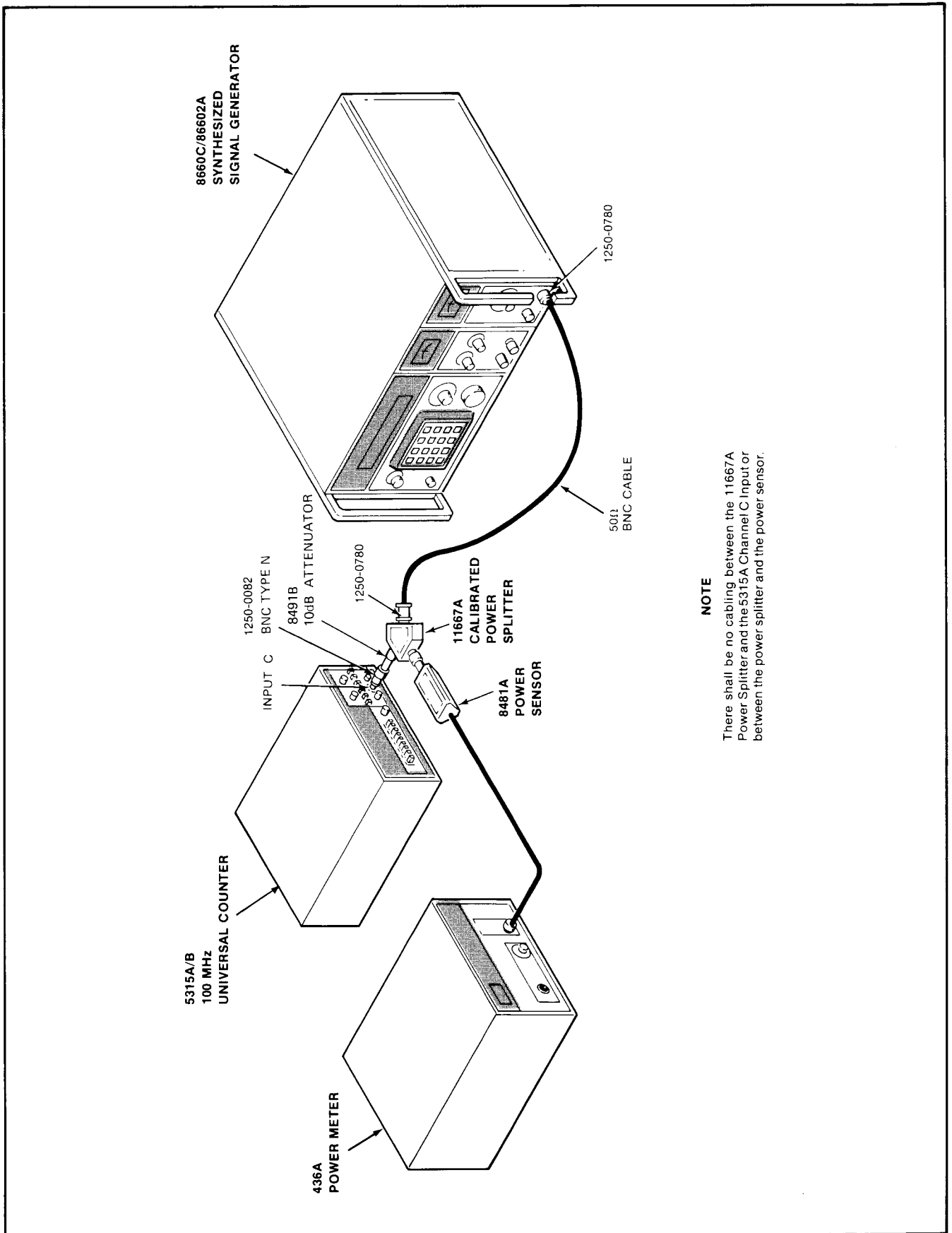

Figure 4-1. Channel C Frequency Response and Sensitivity Test Setup

SECTION V ADJUSTMENTS

5-1. INTRODUCTION

5-2. This section describes the adjustments required to maintain the 5315A/B operating characteristics within specifications. Adjustments should be made when required, such as after a performance test failure or when components are replaced that may affect an adjustment.

5-3. *Table 5-1* is a list of all adjustable components in the 5315A/B and indicates the order in which adjustments should be performed.

5-4. EQUIPMENT REQUIRED

5-5. The test equipment required for the adjustment procedures is listed in *Table 5-1, Recommended Test Equipment*. Substitute instruments may be used if they meet the critical specifications.

5-6. FACTORY SELECTED COMPONENTS

5-7. Factory selected components are shown on schematics with an asterisk by the reference designator. *Table 5-2* lists selected components, possible values and basis for selection.

5-8. ADJUSTMENT LOCATIONS

5-9. *Figures 5-1* through *5-5* illustrate the location of all adjustments and test points used in the 5315A/B adjustment procedures.

WARNING

MAINTENANCE DESCRIBED HEREIN IS PERFORMED WITH POWER SUPPLIED TO THE INSTRUMENT, AND PROTECTIVE COVERS REMOVED. SUCH MAINTENANCE SHOULD BE PERFORMED ONLY BY SERVICE-TRAINED PERSONNEL WHO ARE AWARE OF THE HAZARDS INVOLVED (FOR EXAMPLE, FIRE AND ELECTRICAL SHOCK). WHERE MAINTENANCE CAN BE PERFORMED WITHOUT POWER APPLIED, THE POWER SHOULD BE REMOVED.

BEFORE ANY REPAIR IS COMPLETED, ENSURE THAT ALL SAFETY FEATURES ARE INTACT AND FUNCTIONING, AND THAT ALL NECESSARY PARTS ARE CONNECTED TO THEIR PROTECTIVE GROUNDING MEANS.

Table 5-1. Adjustments

Procedure	Adjustment	Comments
1. 5315A (Only) Power Transformer Primary Line Voltage Selection	A1S3	Set to match available line voltage
2. Power Supply Adjustments	A1R15 A1R11(5315A); A1R12(5315B) A1R22	for +5V for +3V for -5.2V
3. Input Offset Adjustment	A4R32 R1	Channel A Channel B
4. Local Oscillator Adjustment	A13C1 A13C3	Fine Frequency Coarse Frequency
5. Option 001 Adjust	Part of A7Y1	Freq Adj
6. Option 002 Adjust	A6R14, A6R15	Adjustment of 500 mA charger
7. Option 003 Adjust	L, HY, H, CL	A3/A4 assembly must be removed prior to adjustment
8. Option 004 Adjust (5315A)	A14R1 P/O A14Y1	+5V Adj Freq Adj
9. Option 004 Adjust (5315B)	P/O A15Y1	Freq Adj

Table 5-2. Factory Selected Components

Component	Service Sheet Figure No.	Range of Values	Basis For Selection
A13C2	8-14 and 8-16	22 pF nom (15-33 pF)	Selects the capacitor value that gives an output as close as possible to 10 MHz with A13C1 and A13C3 centered.

5-10. ADJUSTMENT PROCEDURES

5-11. 5315A Voltage Selector

5-12. Use the following procedure to change the power transformer primary line voltage switch setting in the 5315A.

- a. Disconnect the power cable from the rear panel of the 5315A.
- b. Turn the 5315A upside down and remove the four screws near the corners of the cabinet bottom.
- c. Holding the top and bottom covers together, turn the 5315A right side up and carefully lift the top cover off.
- d. Refer to *Figure 5-1* which shows the line fuse holder and the line voltage selection switches. Both switch indicators must be set to the line voltage selection marks to match the available line voltage.

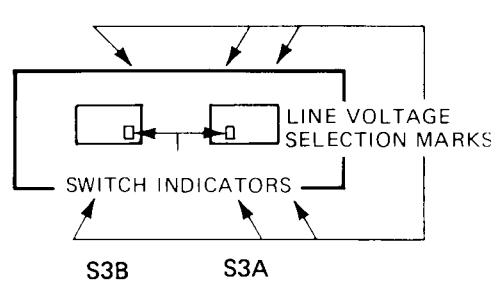
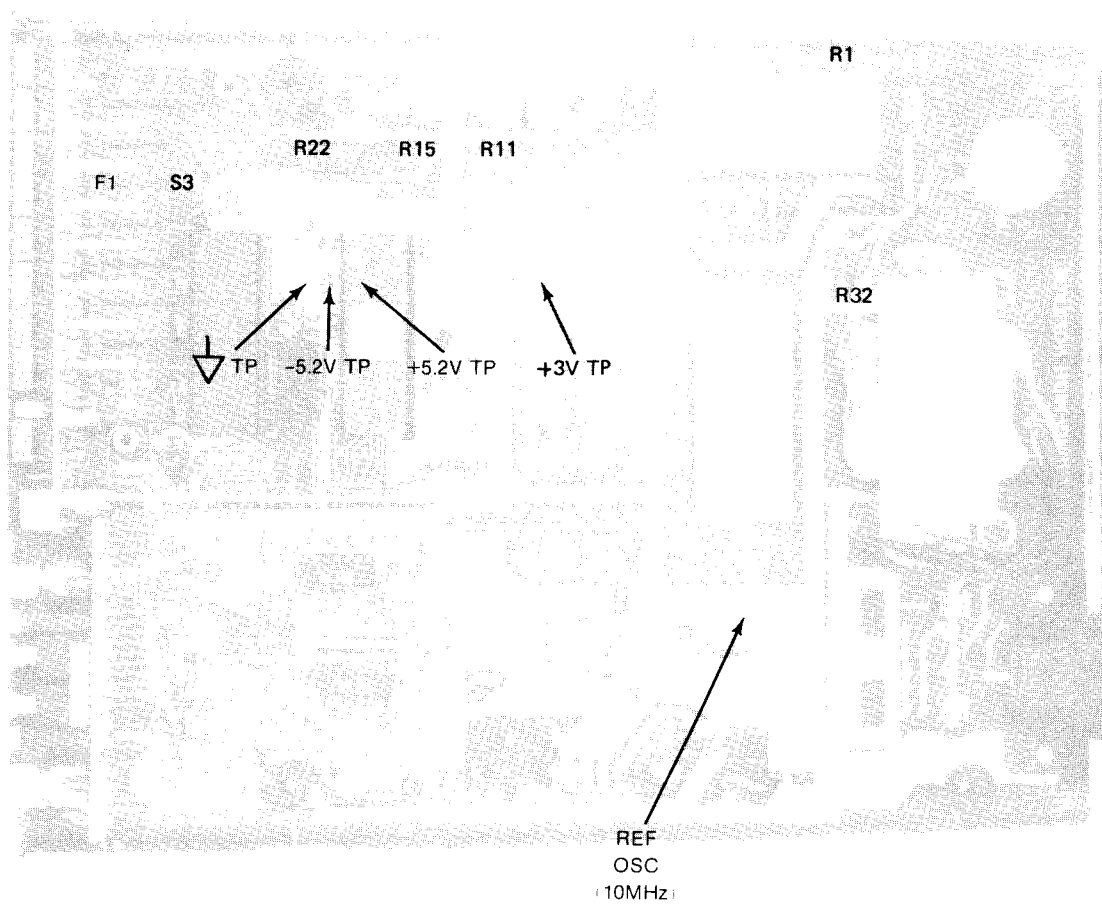

100V	120V	FUSE 250 mAT
220V	240V	FUSE 125 mAT

HP 5315A

Figure 5-1. 5315A Adjustment Component Locations

NOTE

The possible line voltage ranges are listed in Section I, Specifications. Refer to this list to decide where the selection switches should be set.

- e. Set the line voltage switches to appropriate positions for the available line voltage.

CAUTION

Check the line fuse, F1. It must correspond to the line voltage selected. Refer to the specifications in Section I for the correct value fuse.

5-13. Power Supply Adjustments

5-14. The 5315A/B produces three regulated dc supply voltages which should be adjusted in the following order. Refer to *Figures 5-1* or *5-2*.

- a. Connect a DMM to TP +5 and adjust A1R15 for +5V dc $\pm 0.01V$ dc.
- b. Connect a DMM to TP +3 and adjust A1R11 (5315A) or A1R12 (5315B) for +2.85V dc $\pm 0.01V$ dc.
- c. Connect a DMM to TP -5.2 and adjust A1R22 for -5.2V dc $\pm 0.01V$ dc.

5-15. Input Offset Adjustments

5-16. The input offset adjustments are made to the A4 assembly as follows. Refer to *Figures 5-1* or *5-2*.

- a. Connect an oscilloscope to Pin 5 of A4P2.
- b. Using a 50 Ω feedthrough, connect a 10 MHz sine wave to Channel A input BNC.
- c. Set the appropriate Trigger Level/Sensitivity switch to SENS with the control fully clockwise.
- d. Adjust oscilloscope for stable display and then decrease amplitude of 10 MHz sine wave to the minimum allowable (typically 10 mV rms) to maintain display.
- e. Adjust A4R32 for 50-50 duty cycle of the oscilloscope display.
- f. Reconnect oscilloscope to Pin 6 of P2 and 10 MHz sine wave to Channel B input BNC.
- g. Repeat steps c and d.
- h. Adjust A4R1 for 50-50 duty cycle of the oscilloscope display.
- i. This completes the input offset adjustments.

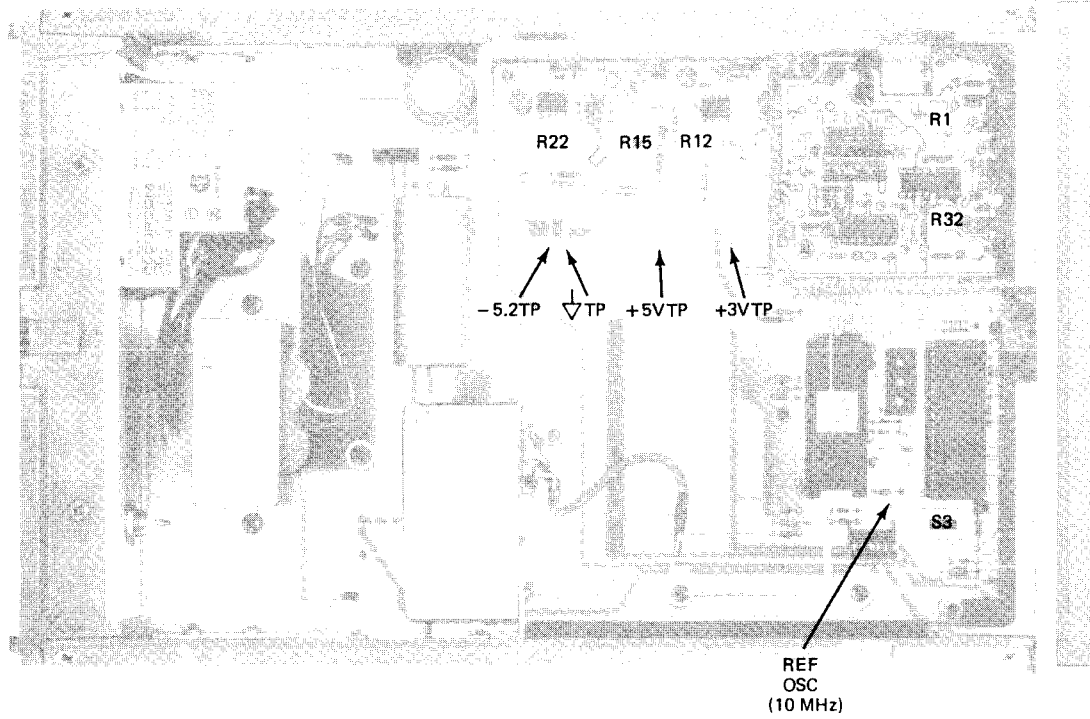

PC BOARD PART NUMBER IS
HP 5020 8122

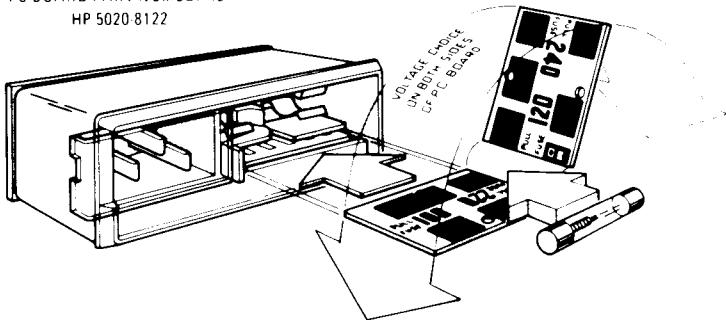

Operating voltage is shown in module window.

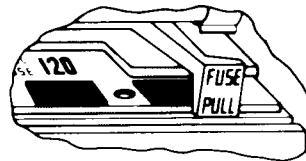

HP 5315B

SELECTION OF OPERATING VOLTAGE

1. Open cover door and rotate fuse pull to left.
2. Select operating voltage by orienting PC board to position desired voltage on top left side. Push board firmly into module slot.
3. Rotate fuse pull back into normal position and re insert fuse in holders, using cautions to select correct fuse value.

Figure 5-2. 5315B Adjustment Component Locations

5-17. Standard Oscillator Adjustment

5-18. Every few months, the reference oscillator should be checked to a known or house frequency standard. When adjustment is required, use the following method. Refer to *Figure 5-3*.

- Connect a known reference frequency (≥ 1 MHz) to Channel A input. See *Table 1-1 Specifications*, for maximum input requirements and range.
- Press function key GATE TIME and insure the Blue Shift key is in the IN position.
- Adjust the GATE TIME control for ≈ 1 second gate.
- Press function key FREQ A and insure that the Blue Shift key is in the OUT position.
- Adjust A13C1 (*FINE*) and if necessary A13C3 (*COARSE*) for the most accurate display of the reference frequency. Refer to A13C2 in *Table 5-2* if the reference frequency cannot be set on the display.

NOTE

The most accurate and stable adjustment will be attained by allowing at least a one hour warmup of the 5315A/B with the covers in place. This allows the instruments internal temperature to stabilize. Perform the adjustment immediately upon removing the cover.

5-19. Option 001 Oscillator Adjustment (TCXO)

5-20. Two procedures are given for the adjustment of Option 001 (TCXO). If the operation of the counter will be solely at 25°C (78°F), adjust the frequency of the oscillator as close to 10 MHz as possible using the first procedure given. If the operation of the counter will be over the full temperature range (0°C to 40°C), then the oscillator must be offset by the marked amount in order to keep the oscillator frequency within the manufacturer’s temperature specification. To adjust the oscillator to the offset frequency, use the second procedure.

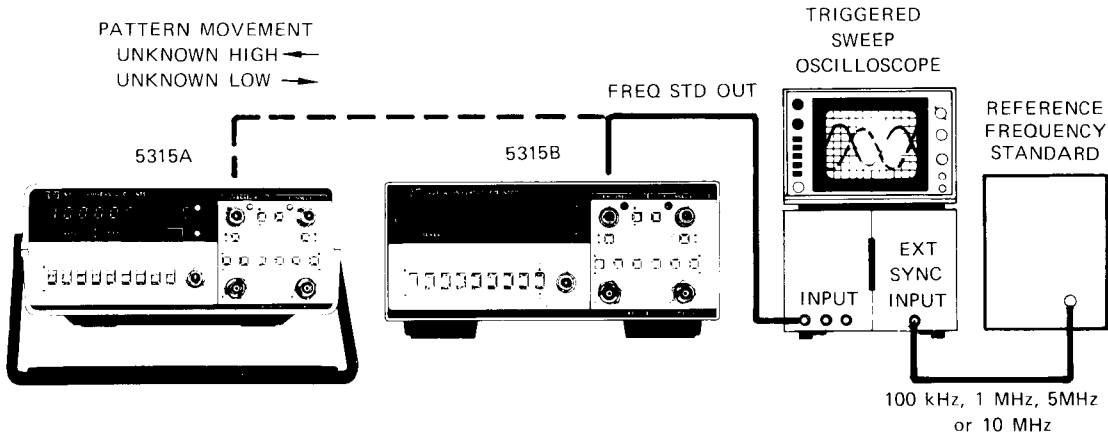

5-21. ADJUSTMENT OF OPTION 001 (FOR OPERATION AT 25°C)

- Connect reference frequency standard to the external SYNC input of the oscilloscope.
- Connect Channel A Input of oscilloscope to the A1 REF OSC test point in the 5315A. The 5315A may be connected via the REFERENCE OUTPUT/INPUT BNC on the rear panel.
- Adjust oscillator frequency for minimum sideways movement of the 10 MHz display signal with ADJ on the TCXO. See *Figure 5-3*.

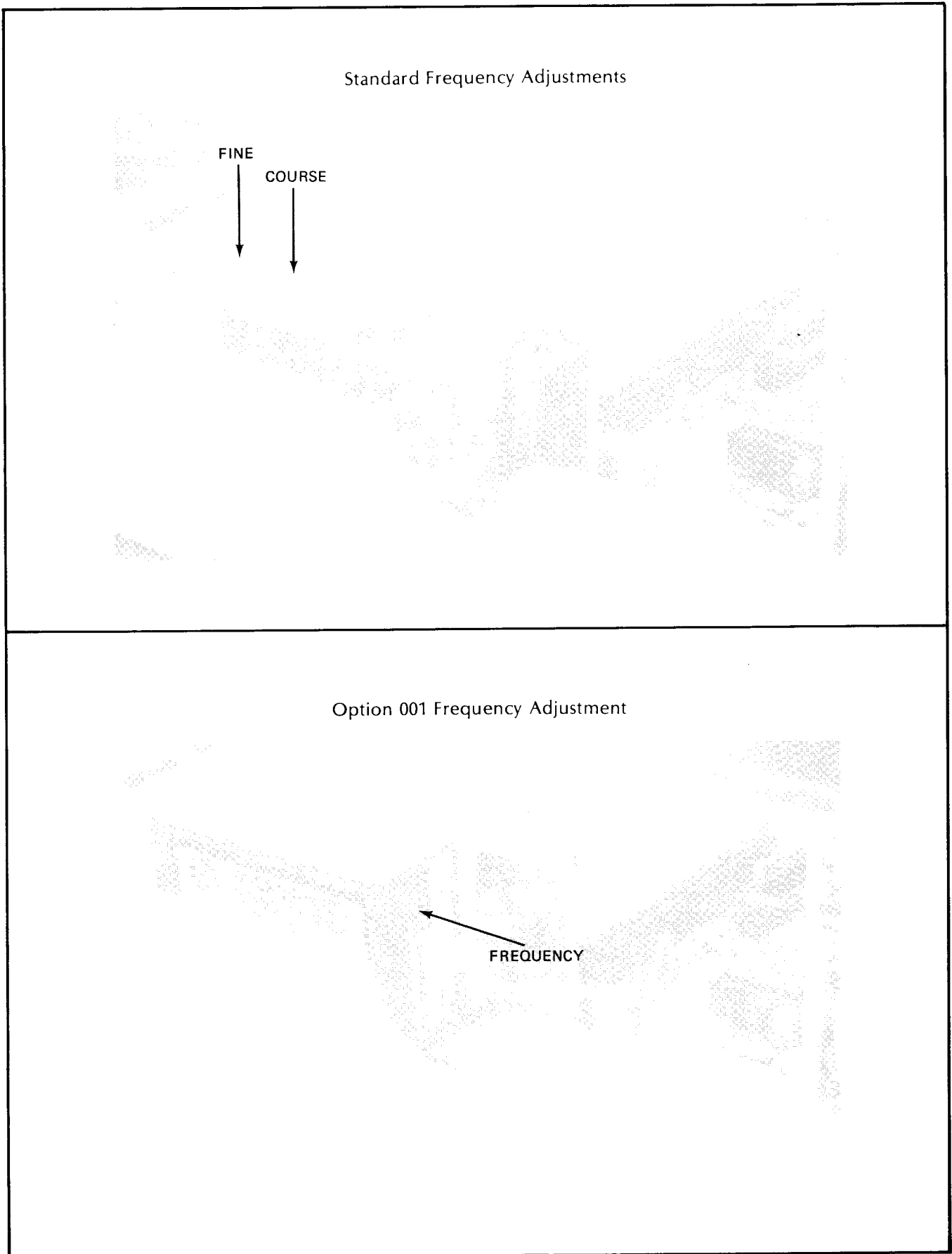

Figure 5-3. Reference Oscillator Adjustment Locations (Standard and Option 001)

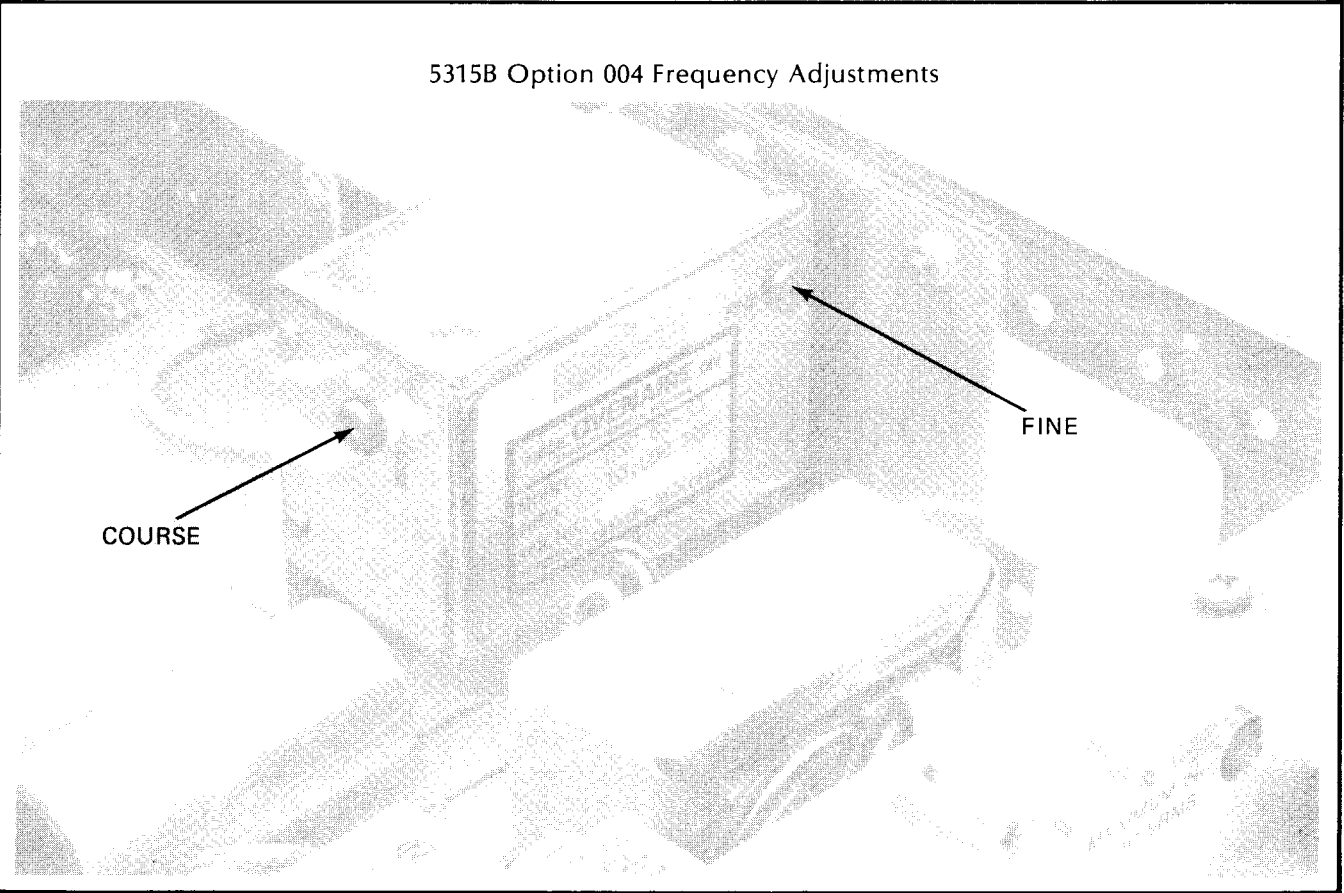
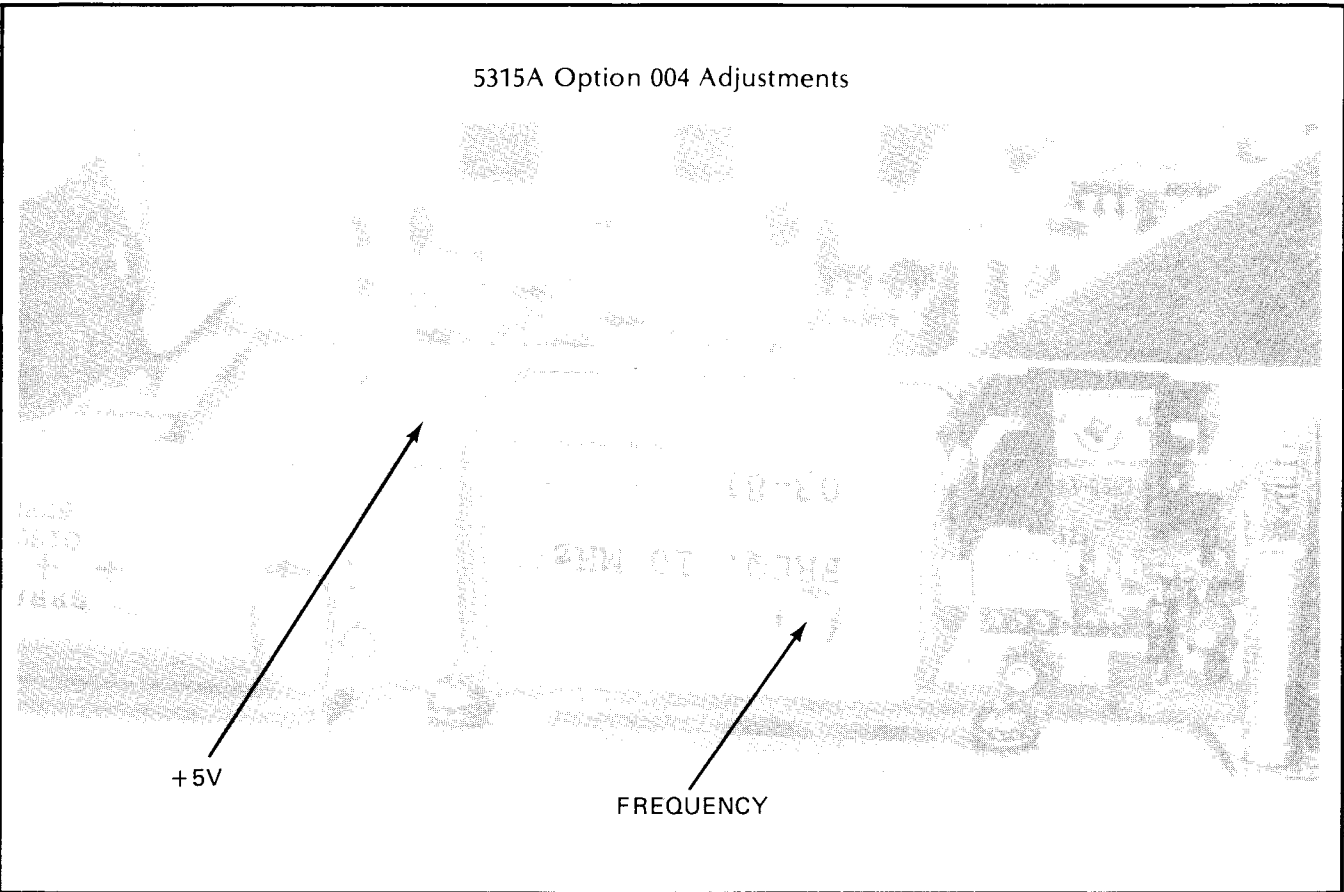

Figure 5-3. Reference Oscillator Adjustment Locations (Option 004)

- d. By timing the sideways movement (in CM per second), the approximate offset can be determined based on the oscilloscope sweep speed as shown in the following:

Movement	SWEEP SPEED			NOTES
	1 $\mu\text{s/cm}$	0.1 $\mu\text{s/cm}$	0.01 $\mu\text{s/cm}$	
1 cm/s	1×10^{-6}	1×10^{-7}	1×10^{-8}	TIME SCOPE TRACE MOVEMENT WITH SECOND HAND OR WATCH OR CLOCK
1 cm/10 s	1×10^{-7}	1×10^{-8}	1×10^{-9}	
1 cm/100 s	1×10^{-8}	1×10^{-9}	1×10^{-10}	

For example, if the trace moves 1 centimeter in 10 seconds and the sweep speed is 0.01 $\mu\text{s/cm}$, the oscillator signal is within 1×10^{-9} of the reference frequency.

5-22. ADJUSTMENT OF OPTION 001 (OPERATION OVER 0°C to 40°C RANGE)

- Connect a reference frequency to the EXT FREQ STD INPUT of a high resolution frequency counter (reciprocal taking) such as an HP 5345A.
- Connect the Channel A input of the 5345A to the Option 001 oscillator signal at A1 "REF OSC" test point. The 5315B may be connected via the REFERENCE OUTPUT/INPUT BNC on the rear panel.
- Adjust the oscillator frequency (via ADJ) for 10 MHz, \pm the offset marked on the TCXO label. For example, if +3.6 Hz is marked on the label, adjust the oscillator for a frequency of 10.0000036 MHz at 25°C. Refer to *Figure 5-3*.

5-23. Option 004 Oven Contained Oscillator Adjustment (5315A/B)

5-24. Initially (to maintain specified accuracy) oven oscillators may require frequent adjustment until they have undergone an aging process. To adjust the 5315A Option 004, the instruments top and bottom cover must be removed. Allow at least one hour of warmup for oven internal temperature to stabilize before attempting adjustment. After adjustment is made, allow a fifteen minute settling period and then verify setting. When adjustment is required, use the following method. Refer to *Figure 5-3*.

- On the 5315A only, verify setting of +5V regulator on oscillator assembly. If necessary, adjust A14R1 (+5V ADJUST) for 5.000V dc \pm 0.025V dc monitored at the +5V pin of the oven module.
- Connect the test equipment as shown in the Option 001 (TCXO) adjustment setup.
- Connect the oscilloscope's Channel A Input to the REF OSC test point on A1 motherboard of the 5315A. Connect the oscilloscope to the REFERENCE OUTPUT/INPUT BNC on the rear panel of the 5315B.
- If adjustment is required, remove the dust cap screw if necessary. The 5315A has only one adjustment while the 5315B has FINE and COARSE adjustments. The COARSE adjustment should be used only when the FINE adjustment does not have sufficient range.
- Adjust the oscillator frequency for a stationary or minimum horizontal movement of the waveform displayed on the oscilloscope.

NOTE

By timing the horizontal movement (in cm per second), the drift rate (compared to the reference standard) can be determined by using the sweep speed table shown for TCXO adjustment.

5-25. Option 002 Battery Charger Adjustment

5-26. The following battery charger adjustment procedure applies to the Model 5315A with serial numbers prefixed 2120A and above. Refer to *Figure 5-4*.

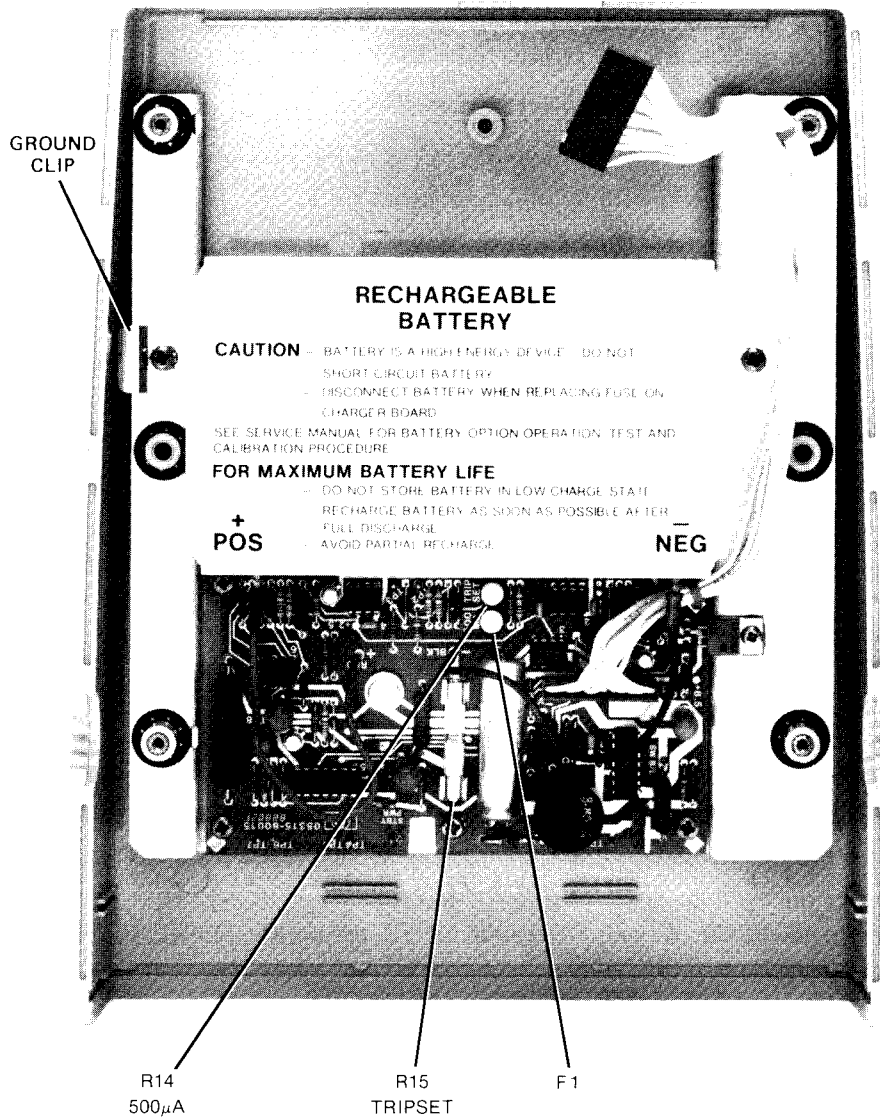

Figure 5-4. Option 002 Battery Charger Adjustment Locations

- a. Disconnect the power cable from the 5315A.
- b. Disconnect the battery from A6 (05315-60015) battery charger assembly board.
- c. Connect cable W4 between A1J4 and A6J1.
- d. Connect the DVM positive lead to W2 (red wire) and negative lead to the ground test point on the battery charger assembly board.
- e. Connect the power cable to 5315A; set the STBY/ON switch to STBY.
- f. Set the TRIP SET adjustment A6R15 fully ccw. Connect a jumper clip between A6TP2 and the ground test point.

CAUTION

Shorting the test points in the next step will cause A6R38 (a large 12 Ω resistor) to heat up. Avoid physical contact with this component. Do not leave shorting clip in place for an extended period of time.

- g. Connect A6TP6 to A6TP7 with a shorting clip.
- h. Set the 500 mA adjustment A6R14 for a DVM reading of 7.71 volts.
- i. Rotate the TRIP SET control A6R15 slowly clockwise until the charging LED (CHGD) just lights. This sets the comparator high trip point.

NOTE

Due to hysteresis of approximately 500 mV in the charge comparator circuit, it is not possible to obtain correct setting by "rocking" the TRIP SET adjustment. The trip point is attainable only by cw rotation of the control. To verify the setting, or to repeat above adjustment, it is necessary to rotate the adjustment slightly ccw from the trip point, and then to reduce the charge voltage below the hysteresis limit. This can be readily accomplished by switching the 5315A power switch to ON, then back to STBY (out).

- j. Connect the negative lead of the DVM to W3 (black wire). Adjust the 500 mA control until the DVM reads 5.00 volts. (This sets the 500 mA charge current.)
- k. Disconnect the shorting clip between A6TP6 and A6TP7.
- l. Set STBY/ON switch to the ON position. Connect A6TP4 and A6TP5 together with a shorting clip. The DVM should read between 1.9 and 2.4 volts. (This verifies operation of the 10 mA current regulator.)
- m. Remove all shorting clips and jumper wires. Turn the instrument off and disconnect the power cable. Disconnect all the test equipment.
- n. Reconnect the charger board red and black wires to the battery observing proper polarity. Be sure that the wire clips are fully engaged.
- o. Replace the top cover. Be sure that the four black spacers (MP4) are in place. As the cover is being positioned, be sure that the leads of the cable assembly W4 will not be pinched between the cover and rear spacer.

5-27. Option 003 1 GHz Channel C Adjustment

5-28. The following procedure describes the adjustments required to maintain the OPTION003 operating characteristics within specifications. Adjustments should be made when required, such as after a performance test failure, or when components are replaced that may affect an adjustment.

5-29. Access to the OPTION 003 test points and adjustments on A9 requires the removal of the A3/A4 Input Switch/Amplifier assembly. To remove and replace the A3/A4 assembly in a 5315A or 5315B, refer to the appropriate procedure that follows.

5-30. 5315A A3/A4 REMOVE/REPLACE PROCEDURE

- a. Remove the AC power cord.
- b. Remove the instrument top cover (MP 12) by removing the four screws accessible from the cabinet bottom.
- c. Remove the LEVEL/SENS and GATE TIME control knobs.
- d. Remove the three screws which secure the motherboard to cabinet bottom. Remove the handle (MP 3) and the four black spacers (MP 4) and lift the entire instrument straight up and out.
- e. Turn the instrument upside-down and carefully remove the brass SMC connector from the A9 INPUT C BNC assembly.
- f. Remove the front panel hex nuts on the CHANNEL A and B BNC's, the three control hex nuts and the 1/4" hex nut on the back side of the display board. Pull the front panel (MP 6) straight out and off.
- g. Remove the four screws securing the A4 Input Amplifier. Remove the A3/A4 assembly by gently lifting on the rear edge of A4, until the pins come free of motherboard connector A1J5.
- h. Reconnect the brass SMC connector to the INPUT C BNC assembly, loosely replace the front panel and set the instrument into the cabinet bottom.
- i. Replace the AC power cord, and refer to the OPTION 003 Adjustment Procedure.
- j. Replacement is the reversal of this procedure.

5-31. 5315B A3/A4 REMOVE/REPLACE PROCEDURE

- a. Remove the AC power cord.
- b. Remove the instrument top cover (MP 12) by removing the screw which secures the carrying handle (MP 11) at rear of instrument. Slide the cover backward until free.
- c. Remove the gray trim strip (MP 16) from top of the instrument front frame (MP 17).
- d. Remove the four screws which secure the front panel (MP 12). The front feet of the instrument must be removed to access the two screws on the frame bottom.

NOTE:

The following two steps only apply to instruments with serial numbers prefixed 1812A through 2032A.

- e. Remove the two screws which secure the support bracket, on the left side of A1 motherboard, to the instrument side frame.
- f. Remove the two screws and bracket which secure the A1 power supply heat sink to the instrument side frame.
- g. Remove the two screws at the rear edge of A1 motherboard.
- h. Disconnect the three power transformer secondary wires (BLU, BLU, WHT-BLU) from the A1 motherboard, by pulling the push-on connectors straight up and off the gold test pins. Remove the OSC OUT wire which connects J8 to A1 motherboard in the same manner.

NOTE

HP 5315B instruments with serial number 1832A00120 or lower do not have push-on connectors on the transformer secondary or EXT REF wires. Carefully solder the wires on these instruments to complete the procedure.

- i. Carefully pull the entire instrument straight forward, through the front frame, and clear of the cabinet.
- j. Remove the LEVEL/SENS and GATE TIME front panel control knobs.
- k. Remove the front panel hex nuts on CHANNEL A and B INPUT BNC's and the three control hex nuts.
- l. Remove the 1/4" hex nuts on the left side (back) of the A2 Display Assembly.
- m. Gently pull the front panel (MP 21) straight forward. Carefully remove the brass SMC connector from the A9 INPUT C BNC assembly. Pull the front panel clear. Note the spacer between the front panel and A2. On older instruments, the spacer is not attached to the front panel.
- n. Remove the four screws securing the A4 Input Amplifier Assembly. Remove the A3/A4 assembly by gently lifting on the rear edge of A4, until the pins come free of motherboard connector A1 J5.
- o. Reconnect the brass SMC connector to the INPUT C BNC assembly and loosely replace the front panel.
- p. Position the cabinet and A1 motherboard assembly side by side, with the cabinet facing to the rear. Route the three power transformer secondary wires through the cabinet side frame and reconnect to A1 motherboard test pins. Insure the wire colors match the pins as labeled.
- q. Carefully replace the AC power cord, and refer to the OPTION 003 Adjustment Procedure.
- r. Replacement is the reversal of this procedure. Be sure that the A1 motherboard fits into the grooves in the board guide.

5-32. OPTION 003 1 GHz CHANNEL C ADJUSTMENT PROCEDURE

5-33. To perform adjustments on OPTION 003, first follow the appropriate disassembly procedure for removal of the A3/A4 Input Switch/Amplifier Assembly. (Refer to Preliminary Disassembly Procedures.)

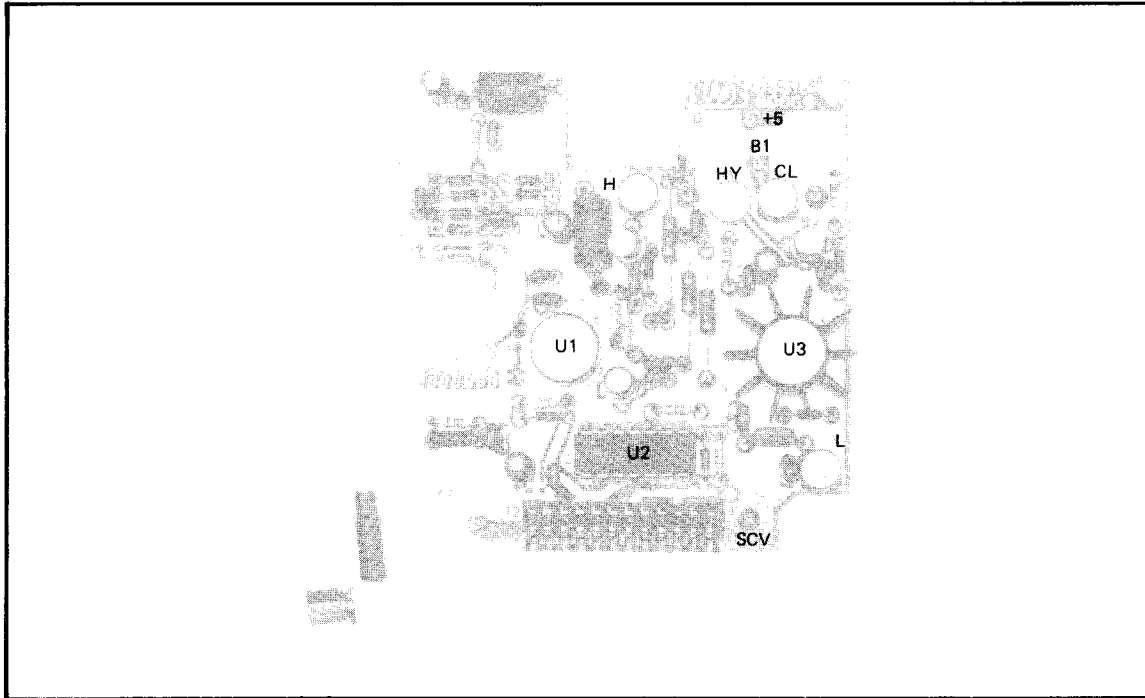

Figure 5-5. Option 003 Channel C Adjustment Locations

- a. Connect a jumper wire between TP marked SCV and the TP marked +5.
- b. Connect a 8660A signal generator to the C Channel input BNC. Set the 8660A for a frequency of 100.000 MHz, at an output level of 0.5V rms.
- c. Connect a 3465A Digital Voltmeter between A9 U2 (pin 8) and ground. Set the adjustment labeled "L" for a reading of $2.6V \pm 5 \text{ mV}$ on the voltmeter.

NOTE

The voltmeter must be a "floating" type.

- d. Reduce the 8660A output level to 0.5 mV rms. Connect the 3465A positive lead to TP "B1" and common lead to TP "B2". Set the adjustment labeled "HY" for a reading of $110 \text{ mV} \pm 1 \text{ mV}$ on the voltmeter.
- e. Increase the 8660A output level to 50 mV rms. Set the adjustment labeled "H" for a reading of $75 \text{ mV} \pm 1 \text{ mV}$ (differential between TP B1 and TP B2) on the voltmeter.
- f. Connect the 3465A positive lead to TP "C". Set the adjustment labeled "CL" for a reading of 37 mV (+1 - 0). The counter display should read $100.0000 \text{ MHz} \pm \text{time base discrepancy} \pm 1 \text{ count}$. (Note: For 5315B, connect EXT REF from 8660A to rear REFERENCE INPUT of counter and set motherboard FREQ STD select switch A1 S3 to EXT.)
- g. Recheck steps d, e, and f to verify all voltages. Repeat steps until all adjustments are within tolerance.
- h. Set the 8660A output level to 75 mV rms at 900 MHz. Verify that the counter displays 900.000 MHz. This completes the adjustment.

SECTION VI REPLACEABLE PARTS

6-1. INTRODUCTION

6-2. This section contains information for ordering parts. *Table 6-1* lists abbreviations used in the parts list and throughout the manual. *Table 6-2* lists all replaceable parts for the standard 5315A/B in reference designation order. *Tables 6-3, 6-4, and 6-5* list replaceable parts for Options 001, 002, and 003, respectively. *Tables 6-6 and 6-7* list parts for Option 004 (5315A and 5313B, respectively). *Table 6-8* contains the names and addresses that correspond with the manufacturer's code numbers. *Table 6-9* lists the 5315A/B hardware. *Figures 6-1 through 6-5* show Cabinet and Option parts.

6-3. ABBREVIATIONS

6-4. *Table 6-1* lists abbreviations used in the parts list, schematics, and throughout the manual. In some cases, two forms of the abbreviation are used, one all in capital letters, and one partial or no capitals. This occurs because the abbreviations in the parts list are always all capitals. However, in the schematics and other parts of the manual, other abbreviations forms are used with lower case and upper case letters.

6-5. REPLACEABLE PARTS

6-6. *Tables 6-2 through 6-7* are the lists of replaceable parts, and are organized as follows:

- a. Electrical assemblies and their components in alphanumerical order by reference designation.
- b. Chassis-mounted parts in alphanumerical order by reference designation.
- c. Miscellaneous parts.

6-7. The information given for each part consists of the following:

- a. The Hewlett-Packard part number.
- b. The part number check digit (CD).
- c. The total quantity (Qty) used in the instrument.
- d. The description of the part.
- e. A typical manufacturer of the part in a five-digit code.
- f. The manufacturer's number for the part.

6-8. The total quantity of each part used within an assembly is given only once at the first appearance of the part number in the list.

6-9. ORDERING INFORMATION

6-10. To order a part listed in the replaceable parts table, quote the Hewlett-Packard part number, indicate the quantity required, and address the order to the nearest Hewlett-Packard office.

6-11. To order a part that is not listed in the replaceable parts table, include the instrument model number, serial number, the description and function of the part, and the number of parts required. Address the order to the nearest Hewlett-Packard office.

SECTION VI REPLACEABLE PARTS

6-1. INTRODUCTION

6-2. This section contains information for ordering parts. *Table 6-1* lists abbreviations used in the parts list and throughout the manual. *Table 6-2* lists all replaceable parts for the standard 5315A/B in reference designation order. *Tables 6-3, 6-4, and 6-5* list replaceable parts for Options 001, 002, and 003, respectively. *Tables 6-6 and 6-7* list parts for Option 004 (5315A and 5313B, respectively). *Table 6-8* contains the names and addresses that correspond with the manufacturer's code numbers. *Table 6-9* lists the 5315A/B hardware. *Figures 6-1 through 6-5* show Cabinet and Option parts.

6-3. ABBREVIATIONS

6-4. *Table 6-1* lists abbreviations used in the parts list, schematics, and throughout the manual. In some cases, two forms of the abbreviation are used, one all in capital letters, and one partial or no capitals. This occurs because the abbreviations in the parts list are always all capitals. However, in the schematics and other parts of the manual, other abbreviations forms are used with lower case and upper case letters.

6-5. REPLACEABLE PARTS

6-6. *Tables 6-2 through 6-7* are the lists of replaceable parts, and are organized as follows:

- a. Electrical assemblies and their components in alphanumerical order by reference designation.
- b. Chassis-mounted parts in alphanumerical order by reference designation.
- c. Miscellaneous parts.

6-7. The information given for each part consists of the following:

- a. The Hewlett-Packard part number.
- b. The part number check digit (CD).
- c. The total quantity (Qty) used in the instrument.
- d. The description of the part.
- e. A typical manufacturer of the part in a five-digit code.
- f. The manufacturer's number for the part.

6-8. The total quantity of each part used within an assembly is given only once at the first appearance of the part number in the list.

6-9. ORDERING INFORMATION

6-10. To order a part listed in the replaceable parts table, quote the Hewlett-Packard part number, indicate the quantity required, and address the order to the nearest Hewlett-Packard office.

6-11. To order a part that is not listed in the replaceable parts table, include the instrument model number, serial number, the description and function of the part, and the number of parts required. Address the order to the nearest Hewlett-Packard office.

Table 6-1. Reference Designations and Abbreviations

REFERENCE DESIGNATIONS

A = assembly	DL = delay line	K = relay	T = transformer
AT = attenuator; isolator; termination	DS = annunciator; signaling device -audible or visual; lamp; LED	L = coil; inductor	TB = terminal board
B = fan; motor	E = miscellaneous electrical part	M = metre	TC = thermocouple
BT = battery	F = fuse	MP = miscellaneous mechanical part	TP = test point
C = capacitor	FL = filter	P = electrical connector -movable portion; plug	U = integrated circuit; microcircuit
CP = coupler	H = hardware	Q = transistor; SCR; triode thyristor	V = electron tube
CR = diode; diode thyristor; varactor	HY = circulator	R = resistor	VR = voltage regulator; breakdown diode
DC = directional coupler	J = electrical connector -stationary portion; jack	RT = thermistor	W = cable; transmission path; wire
		S = switch	X = socket
			Y = crystal unit-piezo-electric
			Z = tuned cavity; tuned circuit

ABBREVIATIONS

A = ampere	HD = head	NE = neon	SPST = single-pole, single-throw
ac = alternating current	HDW = hardware	NEG = negative	SSB = single sideband
ACCESS = accessory	HF = high frequency	nF = nanofarad	SST = stainless steel
ADJ = adjustment	HG = mercury	NI PL = nickel plate	STL = steel
A/D = analog-to-digital	HI = high	N/O = normally open	SQ = square
AF = audio frequency	HP = Hewlett-Packard	NOM = nominal	SWR = standing-wave ratio
AFCC = automatic frequency control	HPF = high pass filter	NORM = normal	SYNC = synchronize
AGC = automatic gain control	HR = hour (used in parts list)	NPN = negative-positive-negative	T = timed (slow-blow fuse)
AL = aluminum	HV = high voltage	NPO = negative-positive zero (zero temperature coefficient)	TA = tantalum
ALC = automatic level control	Hz = hertz	NRFR = not recommended for field replacement	TC = temperature compensating
AM = amplitude modulation	IC = integrated circuit	ns = nanosecond	TD = time delay
AMPL = amplifier	ID = inside diameter	ns = nanosecond	TERM = terminal
APC = automatic phase control	IF = intermediate frequency	NSR = not separately replaceable	TFT = thin-film transistor
ASSY = assembly	IMPG = impregnated	nW = nanowatt	TGL = toggle
AUX = auxiliary	IN = inch	OBD = order by description	THD = thread
AVG = average	INCD = incandescent	OD = outside diameter	THRU = through
AWG = american wire gauge	INCL = includes	OH = oval head	TI = titanium
BAL = balance	INP = input	OP AMPL = operational amplifier	TOL = tolerance
BAT = battery coded decimal	INS = insulation	OPT = option	TRIM = trimmer
BD = board	INT = internal	OSC = oscillator	TSTR = transistor
BE CU = beryllium copper	kg = kilogram	OX = oxide	TTL = transistor-transistor logic
BFO = beat frequency oscillator	kHz = kilohertz	oz = ounce	TV = television
BH = binder head	kΩ = kilohm	Ω = ohm	TVI = television interference
BKDN = breakdown	kV = kilovolt	P = peak (used in parts list)	TWT = traveling wave tube
BP = bandpass	LC = inductance-capacitance	PAM = pulse-amplitude modulation	U = micro (10 ⁻⁶) (used in parts list)
BPF = bandpass filter	LED = light-emitting diode	PC = printed circuit	UF = microfarad (used in parts list)
BRS = brass	LF = low frequency	PCM = pulse-code modulation;	UHF = ultrahigh frequency
BWO = backward-wave oscillator	LG = long	PCM = pulse-count modulation	UNREG = unregulated
CAL = calibrate	LH = left hand	PDM = pulse-duration modulation	V = volt
ccw = counterclockwise	LIM = limit	pF = picofarad	VA = voltampere
CER = ceramic	LIN = linear taper (used in parts list)	PH BRZ = phosphor bronze	Vac = volts ac
CHAN = channel	lin = linear	PHL = phillips	VAR = variable
cm = centimeter	LK WASH = lockwasher	PIN = positive-intrinsic-negative	VCO = voltage-controlled oscillator
CMO = coaxial	LO = low; local oscillator	pk = peak	Vdc = volts dc
COEF = coefficient	LOG = logarithmic taper (used in parts list)	PL = phase lock	VDCW = volts, dc, working (used in parts list)
COM = common	log = logarithmic	PLO = phase lock oscillator	V(F) = volts, filtered
COMP = composition	LPF = low pass filter	PM = phase modulation	VFO = variable-frequency oscillator
COMPL = complete	LV = low voltage	PNP = positive-negative-positive	VHF = very-high frequency
CONN = connector	m = metre (distance)	P/O = part of	Vpk = volts peak
CP = cadmium plate	mA = milliampere	POLY = polystyrene	Vp-p = volts peak-to-peak
CRT = cathode-ray tube	MAX = maximum	PORC = porcelain	Vrms = volts rms
CTL = complementary transistor logic	MEG = meg (10 ⁶) (used in parts list)	POS = positive; position(s) (used in parts list)	VSWR = voltage standing wave ratio
CW = continuous wave	MET FLM = metal film	POSN = position	VTO = voltage-tuned oscillator
cw = clockwise	MET OX = metal oxide	POT = potentiometer	VTVM = vacuum-tube voltmeter
D/A = digital-to-analog	MF = medium frequency; microfarad (used in parts list)	p-p = peak-to-peak	V(X) = volts, switched
dB = decibel	MFR = manufacturer	PP = peak-to-peak (used in parts list)	W = watt
dBm = decibel referred to 1 mW	mg = milligram	PPM = pulse-position modulation	W/ = with
dc = direct current	MHz = megahertz	PREAMPL = preamplifier	WIV = working inverse voltage
deg = degree (temperature interval or difference)	mH = millihenry	PRF = pulse-repetition frequency	WW = wirewound
° = degree (plane angle)	mho = conductance	PRR = pulse repetition rate	W/O = without
°C = degree Celsius (centigrade)	MIN = minimum	ps = picosecond	YIG = yttrium-iron-garnet
°F = degree Fahrenheit	min = minute (time)	PT = point	Zo = characteristic impedance
°K = degree Kelvin	... = minute (plane angle)	PTM = pulse-time modulation	
DEPC = deposited carbon	MINAT = miniature	PWM = pulse-width modulation	
DET = detector	mm = millimetre	PWV = peak working voltage	
diam = diameter	MOD = modulator	RC = resistance capacitance	
DIA = diameter (used in parts list)	MOM = momentary	RECT = rectifier	
DIFF AMPL = differential amplifier	MOS = metal-oxide semiconductor	REF = reference	
div = division	ms = millisecond	REG = regulated	
DPDT = double-pole, double-throw	MTG = mounting	REPL = replaceable	
DR = drive	MTR = meter (indicating device)	RF = radio frequency	
DSB = double sideband	mV = millivolt	RFI = radio frequency interference	
DTL = diode transistor logic	mVdc = millivolt, ac	RH = round head; right hand	
DVM = digital voltmeter	mVdc = millivolt, dc	RLC = resistance-inductance-capacitance	
ECL = emitter coupled logic	mVpk = millivolt, peak	RMO = rack mount only	
EMF = electromotive force	mVp-p = millivolt, peak-to-peak	rms = root-mean-square	
EDP = electronic data processing	mVrms = millivolt, rms	RND = round	
ELECT = electrolytic	mW = milliwatt	ROM = read-only memory	
ENCAP = encapsulated	MUX = multiplex	R&P = rack and panel	
EXT = external	MY = mylar	RWV = reverse working voltage	
F = farad	μA = microampere	S = scattering parameter	
FET = field-effect transistor	μF = microfarad	s = second (time)	
F/F = flip-flop	μH = microhenry	... = second (plane angle)	
FH = flat head	μho = micromho	S-B = slow-blow fuse (used in parts list)	
FOL H = fillister head	μs = microsecond	SCR = silicon controlled rectifier; screw	
FM = frequency modulation	μV = microvolt	SE = selenium	
FP = front panel	μVdc = microvolt, ac	SECT = sections	
FREQ = frequency	μVdc = microvolt, dc	SEMICON = semiconductor	
FXD = fixed	μVpk = microvolt, peak	SHF = superhigh frequency	
g = gram	μVp-p = microvolt, peak-to-peak	SI = silicon	
GE = germanium	μVrms = microvolt, rms	SIL = silver	
GHz = gigahertz	μW = microwatt	SL = slide	
GL = glass	nA = nanoampere	SNR = signal-to-noise ratio	
GND = grounded	NC = no connection	SPDT = single-pole, double-throw	
H = henry	N/C = normally closed	SPG = spring	
h = hour		SR = split ring	
HET = heterodyne			
HEX = hexagonal			

NOTE

All abbreviations in the parts list will be in upper case.

MULTIPLIERS

Abbreviation	Prefix	Multiple
T	tera	10 ¹²
G	giga	10 ⁹
M	mega	10 ⁶
k	kilo	10 ³
da	deka	10
d	deci	10 ⁻¹
c	centi	10 ⁻²
m	milli	10 ⁻³
μ	micro	10 ⁻⁶
n	nano	10 ⁻⁹
p	pico	10 ⁻¹²
f	femto	10 ⁻¹⁵
a	atto	10 ⁻¹⁸

6-12. DIRECT MAIL ORDER SYSTEM

6-13. Within the USA, Hewlett-Packard can supply parts through a direct mail order system. Advantages of using the system are:

- a. Direct ordering and shipment from the HP Parts Center in Mountain View, California.
- b. No maximum or minimum on any mail order (there is a minimum order amount for parts ordered through a local HP office when the orders require billing and invoicing).
- c. Prepaid transportation (there is a small handling charge for each order).
- d. No invoices — to provide these advantages, a check or money order must accompany each order.

6-14. Mail order forms and specific ordering information is available through your local HP office. Addresses and phone numbers are located at the back of this manual.

6-15. SPECIAL PARTS REPLACEMENT CONSIDERATIONS

6-16. Certain mechanical parts and electrical components require special consideration.

- a. 5315B Transformer T1: If the power transformer, T1, must be replaced, order HP Part Number 05315-80001. This transformer assembly includes the connectors.
- b. Front Panels: Eight front panels are available. The standard front panels have no opening for the Option 003 BNC connector. The following part numbers are valid for instruments with serial numbers prefixed 2120A and above.

5315A Standard	05315-00026
5315A Option 003	05315-00027
5315B Standard	05315-00028
5315B Option 003	05315-00029

For instrument with serial numbers prefixed 1812A through 2032A, the part numbers are:

5315A Standard	05315-00003
5315A Option 003	05315-00004
5315B Standard	05315-00007
5315B Option 003	05315-00008

NOTE

Any time a front panel is reinstalled, consideration should be given to panel alignment. The gate time control must have a backup spacer, either a hex nut or washers, to position the panel in the plane determined by the shoulders on the input BNC connectors.

- c. 5315B Side Struts: The left and right side struts differ slightly and should not be interchanged. The left strut has four drilled and tapped holes to facilitate the addition of Option 006 Offset/Normalizer. Viewed from the front, the undrilled right strut is HP Part Number 5020-8830 and the drilled left strut is HP Part Number 5020-8885.

- d. Function Switch Assembly A1S1: The function switches are one complete assembly. If any one section is found to be defective the complete block of switches must be replaced. Care should be taken when removing the switch assembly to avoid damage to the A1 Motherboard. The switch assembly is HP Part Number 3101-2297.
- e. Input Amplifier Assembly A3/A4: If either the Input Switch assembly A3, or the Input Amplifier assembly A4 is to be replaced, both must be replaced as one complete assembly by ordering HP Part Number 05315-60100. Do not attempt to separate the assemblies and replace only one.
- f. The two LSI integrated circuits used in the 5315A/B are available only from Hewlett-Packard. Although the Microcomputer A1U1 is not made by HP, the internal ROM is programmed specifically for the Model 5315A/B. The Multiple Register Counter is manufactured by and is available from Hewlett-Packard.
- g. A1 Motherboard: If the A1 Motherboard is to be replaced, order HP Part Number 05315-60013 for 5315A or 05315-60014 for the 5315B. This assembly will include the two LSI integrated circuits A1U1 and A1U2, the heat sink bracket MP1, the A5 Display Support Assembly, and for the 5315A only, the power transformer.
- h. Bottom Cover MP8: The replacement bottom cover (HP Part Number 5060-9963) does not include the information label. The label must be ordered separately under HP Part Number 7120-7489.
- i. A1 Motherboard Slide Rails: If any of the A1 Motherboard slide rails (0403-0373) are to be replaced, new retainers (0510-1152) should be used. Two are required for each rail. Note that the slide rails are not located directly opposite each other.

Table 6-2. Replaceable Parts

Reference Designation	HP Part Number	C D	Qty	Description	Mfr Code	Mfr Part Number
A1	05315-60013	7	1	MOTHERBOARD ASSEMBLY FOR 5315A ONLY: SERIES 2120	28480	05315-60013
A1C1	0160-4557	0	4	CAPACITOR-FXD .1UF +-20% 50VDC CER	16299	CAC04X7R104M050A
A1C2	0180-0562	1	5	CAPACITOR-FXD 33UF+-20% 10VDC TA	56289	196D336X0010KA1
A1C3	0180-2814	0	1	CAPACITOR-FXD 22UF+-20% 10VDC TA	28480	0180-2814
A1C4	0180-0562	1	1	CAPACITOR-FXD 33UF+-20% 10VDC TA	56289	196D336X0010KA1
A1C5	0160-3879	7	6	CAPACITOR-FXD .01UF +-20% 100VDC CER	28480	0160-3879
A1C6	0160-4554	7	2	CAPACITOR-FXD .01UF +-20% 50VDC CER	28480	0160-4554
A1C7	0160-3879	7	7	CAPACITOR-FXD .01UF +-20% 100VDC CER	28480	0160-3879
A1C8	0160-3879	7	7	CAPACITOR-FXD .01UF +-20% 100VDC CER	28480	0160-3879
A1C9	0160-3879	7	7	CAPACITOR-FXD .01UF +-20% 100VDC CER	28480	0160-3879
A1C10	0160-3879	7	7	CAPACITOR-FXD .01UF +-20% 100VDC CER	28480	0160-3879
A1C11	0180-0562	1	1	CAPACITOR-FXD 33UF+-20% 10VDC TA	56289	196D336X0010KA1
A1C12	0160-4554	7	7	CAPACITOR-FXD .01UF +-20% 50VDC CER	28480	0160-4554
A1C13	0160-4557	0	0	CAPACITOR-FXD .1UF +-20% 50VDC CER	16299	CAC04X7R104M050A
A1C14	0180-2820	8	2	CAPACITOR-FXD .22UF+-20% 35VDC TA	28480	0180-2820
A1C15	0160-3879	7	7	CAPACITOR-FXD .01UF +-20% 100VDC CER	28480	0160-3879
A1C16	0180-0562	1	1	CAPACITOR-FXD 33UF+-20% 10VDC TA	56289	196D336X0010KA1
A1C17	0180-2815	1	1	CAPACITOR-FXD 100UF+-20% 10VDC TA	28480	0180-2815
A1C18	0180-1735	2	1	CAPACITOR-FXD .22UF+-10% 35VDC TA	56289	150D224X9035A2
A1C19	0160-4497	7	1	CAPACITOR-FXD 82PF +-5% 200VDC CER 0+-30	28480	0160-4497
A1C20	0180-2891	3	1	CAPACITOR-FXD 4700UF+100-10% 15VDC AL	28480	0180-2891
A1C21	0180-0562	1	1	CAPACITOR-FXD 33UF+-20% 10VDC TA	56289	196D336X0010KA1
A1C22	0180-2820	8	8	CAPACITOR-FXD .22UF+-20% 35VDC TA	28480	0180-2820
A1C23	0160-4557	0	0	CAPACITOR-FXD .1UF +-20% 50VDC CER	16299	CAC04X7R104M050A
A1C24	0160-4557	0	0	CAPACITOR-FXD .1UF +-20% 50VDC CER	16299	CAC04X7R104M050A
A1C25	0180-2892	4	1	CAPACITOR-FXD 2200UF+75-10% 16VDC AL	28480	0180-2892
A1CR1	1901-0050	3	4	DIODE-SWITCHING 80V 200MA 2NS DO-35	28480	1901-0050
A1CR2	1901-0050	3	3	DIODE-SWITCHING 80V 200MA 2NS DO-35	28480	1901-0050
A1CR3	1901-0050	3	3	DIODE-SWITCHING 80V 200MA 2NS DO-35	28480	1901-0050
A1CR4	1901-0050	3	3	DIODE-SWITCHING 80V 200MA 2NS DO-35	28480	1901-0050
A1CR5	1901-0673	6	1	DIODE-PWR RECT 100V 5A 50S	03508	A15A
A1CR6	1901-0731	7	1	DIODE-PWR RECT 400V 1A	28480	1901-0731
A1CR7	1906-0096	7	1	DIODE-FW BRDG 200V 2A	04713	MDA202
A1F1	2110-0201	0	1	FUSE .25A 250V TD 1.25X.25 UL	75915	313.250
A1J1	1251-4743	0	1	CONNECTOR-AC POWER, MALE	28480	1251-4743
A1J2	1251-4215	1	1	CONNECTOR-6 PIN, FEMALE AS ASSY CONNECTOR (INCL MP2;3B EA.)	28480	1251-4215
A1J4	1251-5370	1	2	CONNECTOR-11 PIN, MALE	28480	1251-5370
A1J5	1251-5281	3	1	CONNECTOR-12 PIN, FEMALE	28480	1251-5281
A1J6	1251-5370	1	1	CONNECTOR-11 PIN, MALE	28480	1251-5370
A1J7	1200-0423	8	1	SOCKET-IC 16-CONT DIP DTP SLDK	28480	1200-0423
A1L1	9100-1637	4	1	INDUCTOR RF-CR-MID 120UH 5% .166DX.395LG	28480	9100-1637
A1MP1	05315-00001	7	1	HEAT SINK	28480	05315-00001
A1MP2	1251-3768	7	38	"E" POST (PART OF J3)	28480	1251-3768
A1Q1	1853-0363	8	1	TRANSISTOR PNP SI PD=50W FT=20MHZ	03508	X45H281
	0340-0468	6	3	INSULATOR-XSTR NYLON	28480	0340-0468
	0340-0864	6	3	INSULATOR-XSTR THRM-CONDCT	28480	0340-0864
A1Q2	1854-0477	7	1	TRANSISTOR NPN 2N2222A SI TO-18 PD=500MW	04713	2N2222A
A1R1	2100-3905	6	1	RESISTOR-VAR W/SW 500K 20% 100W SPDT-NC	28480	2100-3905
A1R2	0698-0084	9	2	RESISTOR 2.15K 1% .125W F TC=0+-100 NOT ASSIGNFD	24546	C4-1/8-T0-2151-F
A1R3						
A1R4	0698-7218	5	2	RESISTOR 178 1% .05W F TC=0+-100	24546	C3-1/8-T0-178R-G
A1R5	0698-7218	5	2	RESISTOR 178 1% .05W F TC=0+-100	24546	C3-1/8-T0-178R-G
A1R6	0757-0199	3	3	RESISTOR 21.5K 1% .125W F TC=0+-100	24546	C4-1/8-T0-2152-F
A1R7	0698-3444	7	1	RESISTOR 196 1% .125W F TC=0+-100	24546	C4-1/8-T0-196R-F
A1R8	0698-3431	6	1	RESISTOR 23.7 1% .125W F TC=0+-100	03888	PM55-1/8-T0-237R-F
A1R9	0698-3442	9	2	RESISTOR 237 1% .125W F TC=0+-100	24546	C4-1/8-T0-237R-F
A1R10	0698-3443	0	1	RESISTOR 287 1% .125W F TC=0+-100	24546	C4-1/8-T0-287R-F
A1R11	2100-0568	1	2	RESISTOR-TRMR 130 10% C TOP-ADJ 1-TRN	28480	2100-0568
A1R12	0757-0199	3	3	RESISTOR 21.5K 1% .125W F TC=0+-100	24546	C4-1/8-T0-2152-F
A1R13	0698-3434	9	1	RESISTOR 34.8 1% .125W F TC=0+-100	24546	C4-1/8-T0-348R-F
A1R14	0698-3157	3	1	RESISTOR 19.6K 1% .125W F TC=0+-100	24546	C4-1/8-T0-1962-F
A1R15	2100-3252	6	1	RESISTOR-TRMR 5K 10% C TOP-ADJ 1-TRN	28480	2100-3252
A1R16	0698-0084	9	2	RESISTOR 2.15K 1% .125W F TC=0+-100	24546	C4-1/8-T0-2151-F
A1R17	0757-0199	3	3	RESISTOR 21.5K 1% .125W F TC=0+-100	24546	C4-1/8-T0-2152-F
A1R18	0698-0280	3	3	RESISTOR 1K 1% .125W F TC=0+-100	24546	C4-1/8-T0-1001-F
A1R19	0698-3442	9	2	RESISTOR 237 1% .125W F TC=0+-100	24546	C4-1/8-T0-237R-F
A1R20	0757-0403	2	1	RESISTOR 121 1% .125W F TC=0+-100	24546	C4-1/8-T0-121R-F

See introduction to this section for ordering information
*Indicates factory selected value

Table 6-2. Replaceable Parts (Continued)

Reference Designation	HP Part Number	C D	Qty	Description	Mfr Code	Mfr Part Number
A1R21	0698-3444	1	1	RESISTOR 316 1% .125W F TC=0+-100	24546	CA-1/8-T0-316R-F
A1R22	2100-0568	1		RESISTOR-TRMR 100 10% C TGP ADJ 1-TRN	28480	2100-0568
A1R23	0757-0280	3		RESISTOR 1K 1% .125W F TC=0+-100	24546	CA-1/8-T0-1001-F
A1R24	0757-0280	3		RESISTOR 1K 1% .125W F TC=0+-100	24546	CA-1/8-T0-1001-F
A1S1	3101-2297	0	1	SWITCH-PR 9-STATTON 10MM C-C SPACING PART OF A1R1	28480	3101-2297
A1S2						
A1S3	3101-0693	6	1	SWITCH-SL 2-DDDT STD 1.5A 250VAC PC	28480	3101-0693
A1T1				REFER TO T1 UNDER 5315A CHASSIS PARTS		
A1U1	1820-2131	3	1	IC	04713	MC3076P
A1U2	1820-2312	2	1	IC MISC	28480	1820-2312
A1U3	1826-0412	1	1	IC COMPARATOR PRCN DUAL 8-DIP-P PKG	27014	LM393N
A1U4	1826-0346	0	1	IC OP AMP 5P DUAL 8-DIP-P PKG	27014	LM358N
A1U5	1826-0393	7	1	IC V RGLTR T0-220	27014	LM317T
	0340-0468	6		INSULATOR-XSTR NYLON	28480	0340-0468
	0340-0864	6		INSULATOR-XSTR THRM-CONDCT	28480	0340-0864
A1U6	1826-0544	0	1	V REF 8-DIP-C	04713	MC1403U
A1U7	1826-0527	9	1	IC 3.3V V RGLTR T0-220	27614	LM337T
	0340-0468	6		INSULATOR-XSTR NYLON	28480	0340-0468
	0340-0864	6		INSULATOR-XSTR THRM-CONDCT	28480	0340-0864
A1XF1	2110-0269	0	2	FUSEH01 DFR-CLIP TYPE.250-FUSE	28480	2110-0269
A1XU1	1200-0552	4	2	SOCKET-IC 40-CONT DIP-SLDR	28480	1200-0552
A1XU2	1200-0552	4		SOCKET-IC 40-CONT DIP-SLDR A1 MISCELLANEOUS PARTS	28480	1200-0552
	0380-0745	6	4	STANDOFF-RVT-ON .187-IN-LG 6-32THD	00000	ORDER BY DESCRIPTION
	0380-0770	7	6	STANDOFF-RVT-ON .075-IN-LG 6-32THD	00000	ORDER BY DESCRIPTION
	0380-0906	1	2	STANDOFF-RVT-ON .1-IN-LG 6-32THD	00000	ORDER BY DESCRIPTION
	1251-0600	0	1	CONNECTOR-SGL CONT PIN 1.14-MM-BSC-SZ 50	28480	1251-0600

See introduction to this section for ordering information
*Indicates factory selected value

Table 6-2. Replaceable Parts (Continued)

Reference Designation	HP Part Number	C D	Qty	Description	Mfr Code	Mfr Part Number
A1	05315-60014	0	1	MOTHERBOARD ASSEMBLY FOR 5315B ONLY: SERIES 2120	28480	05315-60014
A1C1	0160-4557	0	4	CAPACITOR-FXD .10UF +-20% 50VDC CER	16299	CAC04X7R104M050A
A1C2	0180-0562	1	3	CAPACITOR-FXD 330F+-20% 10VDC TA	56289	196D336X0010KA1
A1C3	0180-2698	0	1	CAPACITOR-FXD 4.7UF+-10% 35VDC TA	28480	0180-2698
A1C4	0180-0562	1	1	CAPACITOR-FXD 330F+-20% 10VDC TA	56289	196D336X0010KA1
A1C5	0160-3879	7	6	CAPACITOR-FXD .01UF +-20% 100VDC CER	28480	0160-3879
A1C6	0160-4554	7	4	CAPACITOR-FXD .01UF +-20% 50VDC CER	28480	0160-4554
A1C7	0160-3879	7	7	CAPACITOR-FXD .01UF +-20% 100VDC CER	28480	0160-3879
A1C8	0160-3879	7	7	CAPACITOR-FXD .01UF +-20% 100VDC CER	28480	0160-3879
A1C9	0160-3879	7	7	CAPACITOR-FXD .01UF +-20% 100VDC CER	28480	0160-3879
A1C10	0160-4554	7	7	CAPACITOR-FXD .01UF +-20% 50VDC CER	28480	0160-4554
A1C11	0160-4554	7	7	CAPACITOR-FXD .01UF +-20% 50VDC CER	28480	0160-4554
A1C12	0160-3879	7	7	CAPACITOR-FXD .01UF +-20% 100VDC CER	28480	0160-3879
A1C13	0180-0562	1	1	CAPACITOR-FXD 330F+-20% 10VDC TA	56289	196D336X0010KA1
A1C14	0160-4554	7	7	CAPACITOR-FXD .01UF +-20% 50VDC CER	28480	0160-4554
A1C15	0160-4557	0	0	CAPACITOR-FXD .10UF +-20% 50VDC CER	16299	CAC04X7R104M050A
A1C16	0180-2816	2	2	CAPACITOR-FXD 680F+-20% 10VDC TA	28480	0180-2816
A1C17	0180-2820	8	3	CAPACITOR-FXD .22UF+-20% 35VDC TA	28480	0180-2820
A1C18	0160-3879	7	7	CAPACITOR-FXD .01UF +-20% 100VDC CER	28480	0160-3879
A1C19	0180-2815	1	1	CAPACITOR-FXD 1000F+-20% 10VDC TA	28480	0180-2815
A1C20	0180-2820	8	8	CAPACITOR-FXD .22UF+-20% 35VDC TA	28480	0180-2820
A1C21	0180-1735	2	1	CAPACITOR-FXD .22UF+-10% 35VDC TA	56289	150D224X9035A2
A1C22	0160-4497	7	1	CAPACITOR-FXD 80PF +-5% 200VDC CER 0+-30	28480	0160-4497
A1C23	0180-2816	2	2	CAPACITOR-FXD 680F+-20% 10VDC TA	28480	0180-2816
A1C24	0180-2820	8	8	CAPACITOR-FXD .22UF+-20% 35VDC TA	28480	0180-2820
A1C25	0180-2891	3	1	CAPACITOR-FXD 47000F+100-10% 15VDC AL	28480	0180-2891
A1C26	0180-2892	4	1	CAPACITOR-FXD 22000F+75-10% 16VDC AL	28480	0180-2892
A1C27	0160-4557	0	0	CAPACITOR-FXD .10UF +-20% 50VDC CER	16299	CAC04X7R104M050A
A1C28	0160-4557	0	0	CAPACITOR-FXD .10UF +-20% 50VDC CER	16299	CAC04X7R104M050A
A1CR1	1901-0050	3	5	DIODE-SWITCHING 80V 200MA 2NS DO-35	28480	1901-0050
A1CR2	1901-0050	3	5	DIODE-SWITCHING 80V 200MA 2NS DO-35	28480	1901-0050
A1CR3	1901-0050	3	5	DIODE-SWITCHING 80V 200MA 2NS DO-35	28480	1901-0050
A1CR4	1901-0050	3	5	DIODE-SWITCHING 80V 200MA 2NS DO-35	28480	1901-0050
A1CR5	1901-0050	3	5	DIODE-SWITCHING 80V 200MA 2NS DO-35	28480	1901-0050
A1CR6	1906-0096	7	1	DIODE-FW BRDG 200V 2A	04713	MDA202
A1J1				NOT ASSIGNED		
A1J2	1251-4215	1	1	CONNECTOR-6 PIN, FEMALE	28480	1251-4215
A1J3				A5 ASSY CONNECTOR (INCL MP2; 3B EA)		
A1J4				NOT ASSIGNED		
A1J5	1251-5281	3	1	CONNECTOR-12 PIN, FEMALE	28480	1251-5281
A1J6	1251-5237	9	1	CONNECTOR-11 PIN, MALE	28480	1251-5237
A1J7	1200-0423	8	1	SOCKET-IC 16-CONT DIP DIP-SLDR	28480	1200-0423
A1L1	9100-1637	4	1	INDUCTOR RF-CO-MLD 120UH 5% .166DX.385IG	28480	9100-1637
A1MP1	05315-00001	7	1	HEAT SINK	28480	05315-00001
A1MP2	1251-3768	7	3B	"F" POST (PART OF J3)	28480	1251-3768
A1Q1	1853-0363	8	1	TRANSISTOR PNP SI PD=50W FT=20MHZ	03508	X454281
	0340-0468	6	3	INSULATOR-XSTR NYLON	28480	0340-0468
	0340-0864	6	3	INSULATOR-XSTR THRM-CNDCT	28480	0340-0864
A1Q2	1854-0477	7	1	TRANSISTOR NPN 2N2222A SI TO-18 PD=500MW	04713	2N2222A
A1R1	2100-3905	6	1	RESISTOR-VAR W/SW 500K 20% 10CW SPDT-NC	28480	2100-3905
A1R2	0698-0084	9	2	RESISTOR 2.15K 1% .125W F TC=0+-100	24546	C4-1/8-T0-2151-F
A1R3				NOT ASSIGNED		
A1R4	0698-7218	5	2	RESISTOR 178 1% .05W F TC=0+-100	24546	C3-1/8-T0-178R-G
A1R5	0698-7218	5	2	RESISTOR 178 1% .05W F TC=0+-100	24546	C3-1/8-T0-178R-G
A1R6	0698-0082	7	1	RESISTOR 464 1% .125W F TC=0+-100	24546	C4-1/8-T0-4640-F
A1R7	0757-0199	3	2	RESISTOR 21.5K 1% .125W F TC=0+-100	24546	C4-1/8-T0-2152-F
A1R8	0698-3440	7	1	RESISTOR 196 1% .125W F TC=0+-100	24546	C4-1/8-T0-196R-F
A1R9	0698-3431	6	1	RESISTOR 23.7 1% .125W F TC=0+-100	03688	PME55-1/8-T0-237R-F
A1R10	0698-3442	9	2	RESISTOR 237 1% .125W F TC=0+-100	24546	C4-1/8-T0-237R-F
A1R11	0698-3443	0	1	RESISTOR 287 1% .125W F TC=0+-100	24546	C4-1/8-T0-287R-F
A1R12	2100-0568	1	2	RESISTOR-TRMR 100 10% C TOP-ADJ 1-TRN	28480	2100-0568
A1R13	0698-3474	9	1	RESISTOR 34.8 1% .125W F TC=0+-100	24546	C4-1/8-T0-3480-F
A1R14	0698-3157	3	1	RESISTOR 19.6K 1% .125W F TC=0+-100	24546	C4-1/8-T0-1962-F
A1R15	2100-3252	6	1	RESISTOR-TRMR 5K 10% C TOP-ADJ 1-TRN	28480	2100-3252
A1R16	0698-0084	9	2	RESISTOR 2.15K 1% .125W F TC=0+-100	24546	C4-1/8-T0-2151-F
A1R17	0757-0199	3	2	RESISTOR 21.5K 1% .125W F TC=0+-100	24546	C4-1/8-T0-2152-F
A1R18	0757-0200	3	3	RESISTOR 1K 1% .125W F TC=0+-100	24546	C4-1/8-T0-1001-F
A1R19	0698-3442	9	2	RESISTOR 237 1% .125W F TC=0+-100	24546	C4-1/8-T0-237R-F
A1R20	0757-0403	2	1	RESISTOR 121 1% .125W F TC=0+-100	24546	C4-1/8-T0-121R-F

See introduction to this section for ordering information
*Indicates factory selected value

Table 6-2. Replaceable Parts (Continued)

Reference Designation	HP Part Number	C D	Qty	Description	Mfr Code	Mfr Part Number
A1R21	0698-3444	1	1	RESISTOR 316 1% .125W F TC=0+-100	24546	C4-1/8-T0-316R-F
A1R22	2100-0568	1		RESISTOR-TTRR 100 10% C TOP ADJ 1 TRN	28480	2100-0568
A1R23	0757-0280	3		RESISTOR 1K 1% .125W F TC=0+-100	24546	C4-1/8-T0-1001-F
A1R24	0757-0280	3		RESISTOR 1K 1% .125W F TC=0+-100	24546	C4-1/8-T0-1001-F
A1S1	3101-2297	0	1	SWITCH-PB 9-STATION 10MM C-C SPACING PART OF A1R1	28480	3101-2297
A1S2						
A1S3	3101-2334	6	1	SWITCH-SL DPDT SUBMIN .5A 125VAC/DC PC	28480	3101-2334
A1TP1	1251-0600	0		CONNECTOR-SGL CONT PIN 1.14 MM BSC SZ 50	28480	1251-0600
A1U1	1820-2131	3	1	IC	04713	MC3070P
A1U2	1820-2312	2	1	IC MISC	28480	1820-2312
A1U3	1826-0393	7	1	IC V RGLTR TO-220	27014	LM317T
	0340-0468	6		INSULATOR-XSTR NYLON	28480	0340-0468
	0340-0864	6		INSULATOR-XSTR THRM-CNDCT	28480	0340-0864
A1U4	1826-0346	0	1	IC OP AMP GP DUAL 8-DIP-P PKG	27014	LM358N
A1U5	1826-0527	9	1	IC 337 V RGLTR TO-220	27014	LM337T
	0340-0468	6		INSULATOR-XSTR NYLON	28480	0340-0468
	0340-0864	6		INSULATOR-XSTR THRM-CNDCT	28480	0340-0864
A1U6	1826-0544	0	1	V REF 8-DIP-C	04713	MC1403U
A1XU1	1200-0552	4	2	SOCKET-IC 40-CONT DIP-SLDR	28480	1200-0552
A1XU2	1200-0552	4	4	SOCKET-IC 40-CONT DIP-SLDR A1 MISCELLANEOUS PARTS	28480	1200-0552
	0380-0745	6	4	STANDOFF-RVT-ON .187-IN-LG 6-32THD	00000	ORDER BY DESCRIPTION
	0380-0770	7	6	STANDOFF-RVT-ON .1875-IN-LG 6-32THD	00000	ORDER BY DESCRIPTION
	0380-0906	1	2	STANDOFF-RVT-ON .1-IN-LG 6-32THD	00000	ORDER BY DESCRIPTION
	1251-0600	0	8	CONNECTOR-SGL CONT PIN 1.14 MM BSC SZ 50	28480	1251-0600

See introduction to this section for ordering information
*Indicates factory selected value

Table 6-2. Replaceable Parts (Continued)

Reference Designation	HP Part Number	C D	Qty	Description	Mfr Code	Mfr Part Number
A2	05315-60012	6	1	DISPLAY ASSEMBLY, SERIES 1924	20400	05315-60012
A2C1	0180-2929	B	1	CAPACITOR FX0 76LF+ 10% 1000C 1A	20480	0180-2929
A2DS0	1990-0730	3	9	DISPLAY-NUM-SEG 1-CHAR .3-H RED	20480	5082-7611
A2DS1	1990-0730	3	8	DISPLAY-NUM-SEG 1-CHAR .3-H RED	20480	5082-7611
A2DS2	1990-0730	3		DISPLAY-NUM-SEG 1-CHAR .3-H RED	20480	5082-7611
A2DS3	1990-0730	3		DISPLAY-NUM-SEG 1-CHAR .3-H RED	20480	5082-7611
A2DS4	1990-0730	3		DISPLAY-NUM-SEG 1-CHAR .3-H RED	20480	5082-7611
A2DS5	1990-0730	3		DISPLAY-NUM-SEG 1-CHAR 3-H RED	28480	5082-7611
A2DS6	1990-0730	3		DISPLAY-NUM-SEG 1-CHAR 3-H RED	28480	5082-7611
A2DS7	1990-0730	3		DISPLAY-NUM-SEG 1-CHAR 3-H RED	28480	5082-7611
A2DS8	1990-0730	3		DISPLAY-NUM-SEG 1-CHAR 3-H RED	28480	5082-7611
A2DS9	1990-0752	4	1	LED-LAMP LUM-INT=1MCD IF=35MA-MAX BUR=5V	50522	MV57124
A2DS10	1990-0517	4	7	LED-LAMP LUM-INT=3MCD IF=20MA-MAX BUR=5V	20480	5082-4655
A2DS11	1990-0517	4		LED-LAMP LUM-INT=3MCD IF=20MA-MAX BUR=5V	20480	5082-4655
A2DS12	1990-0517	4		LED-LAMP LUM-INT=3MCD IF=20MA-MAX BUR=5V	20480	5082-4655
A2DS13	1990-0517	4		LED-LAMP LUM-INT=3MCD IF=20MA-MAX BUR=5V	20480	5082-4655
A2DS14	1990-0517	4		LED-LAMP LUM-INT=3MCD IF=20MA-MAX BUR=5V	20480	5082-4655
A2DS15	1990-0517	4		LED-LAMP LUM-INT=3MCD IF=20MA-MAX BUR=5V	20480	5082-4655
A2DS16	1990-0517	4		LED-LAMP LUM-INT=3MCD IF=20MA-MAX BUR=5V	20480	5082-4655
A2J1A	1251-5344	9	1	CONNECTOR 12-PIN F POST TYPE	20480	1251-5344
A2J1B	1251-5345	0	1	CONNECTOR 7-PIN F POST TYPE	20480	1251-5345
A2L1	9180-1610	1	1	INDUCTOR RE-CH MLD 5.60H 10%	20480	9180-1610
A2R1	0757-0390	4	1	RESISTOR 75 1% .125W F TC=0+-100	24546	C4-1/8-T0-75R0-F
A2R2	0757-0401	0	1	RESISTOR 100 1% .125W F TC=0+-100	24546	C4-1/8-T0-101-F
A2R3	0698-3430	3	1	RESISTOR 147 1% .125W F TC=0+-100	24546	C4-1/8-T0-147R-F
A2R4	0698-3442	9	1	RESISTOR 232 1% .125W F TC=0+-100	24546	C4-1/8-T0-232R-F
A2U1	1020-1199	1	1	IC INV TTL LS HEX 1-IMP	01295	SN74LS04N
A2U2	1020-1680	3	1	IC DCDR TTL LS BCD TO-7-SEG	01295	SN74LS247N
A2U3	1020-2132	4	1	IC DRVR CMOS LED DRVR	32293	ICN7218A
A2XD0	1200-0679	6	10	SOCKET-IC 14-CONT DIP DIP-SLDR	20480	1200-0679
A2XD01	1200-0679	6		SOCKET-IC 14-CONT DIP DIP-SLDR	20480	1200-0679
A2XD02	1200-0679	6		SOCKET-IC 14-CONT DIP DIP-SLDR	20480	1200-0679
A2XD03	1200-0679	6		SOCKET-IC 14-CONT DIP DIP-SLDR	20480	1200-0679
A2XD04	1200-0679	6		SOCKET-IC 14-CONT DIP DIP-SLDR	20480	1200-0679
A2XD05	1200-0679	6		SOCKET-IC 14-CONT DIP DIP-SLDR	20480	1200-0679
A2XD06	1200-0679	6		SOCKET-IC 14-CONT DIP DIP-SLDR	20480	1200-0679
A2XD07	1200-0679	6		SOCKET-IC 14-CONT DIP DIP-SLDR	20480	1200-0679
A2XD08	1200-0679	6		SOCKET-IC 14-CONT DIP DIP-SLDR	20480	1200-0679
A2XU1	1200-0679	6		SOCKET-IC 14-CONT DIP DIP-SLDR	20480	1200-0679
A2XU2	1200-0473	0	1	SOCKET-IC 16-CONT DIP DIP-SLDR	20480	1200-0473
A2XU3	1200-0567	1	1	SOCKET-IC 20-CONT DIP DIP-SLDR	20480	1200-0567
	1251-3760	7	1	CONTACT-CORN U/W-POST-TYPE MALE DP/SLDR	20480	1251-3760

See introduction to this section for ordering information
*Indicates factory selected value

Table 6-2. Replaceable Parts (Continued)

Reference Designation	HP Part Number	C D	Qty	Description	Mfr Code	Mfr Part Number
A3/A4	05315-60100	3		INPUT/AMPLIFIER ASSEMBLY NOTE: THE A3 & A4 ASSEMBLIES ARE ONLY SUPPLIED AS ONE UNIT UNDER HP PART NO. 05315-60100. THE COMPONENTS OF EACH ASSEMBLY ARE LISTED AS FOLLOWS:	28480	05315-60100
A3	05315-60003	5	1	INPUT BOARD ASSEMBLY, SERIES 2024	28480	05315-60003
A3C1	0160-4704	9	7	CAPACITOR-FXD .01UF +-10% 500VDC CER	28480	0160-4704
A3C2	0160-4704	9		CAPACITOR-FXD .01UF +-10% 500VDC CER	28480	0160-4704
A3C3	0180-0562	1	2	CAPACITOR-FXD 33UF+-20% 10VDC TA	56289	196D336X0010KA1
A3C4	0160-4705	0	2	CAPACITOR-FXD 2.2PF +-5% 500VDC CER	28480	0160-4705
A3C5	0160-4703	0	1	CAPACITOR-FXD 66PF +-5% 500VDC CER 0+-30	28480	0160-4703
A3C6	0160-4704	9		CAPACITOR-FXD .01UF +-10% 500VDC CER	28480	0160-4704
A3C7	0160-4704	9		CAPACITOR-FXD .01UF +-10% 500VDC CER	28480	0160-4704
A3C8	0160-3877	5	1	CAPACITOR-FXD 100PF +-20% 200VDC CER	28480	0160-3877
A3C9	0160-4705	0		CAPACITOR-FXD 2.2PF +-5% 500VDC CER	28480	0160-4705
A3C10	0160-4704	9		CAPACITOR-FXD .01UF +-10% 500VDC CER	28480	0160-4704
A3C11	0180-0562	1		CAPACITOR-FXD 33UF+-20% 10VDC TA	56289	196D336X0010KA1
A3C12	0160-4704	9		CAPACITOR-FXD .01UF +-10% 500VDC CER	28480	0160-4704
A3C13	0160-4704	9		CAPACITOR-FXD .01UF +-10% 500VDC CER	28480	0160-4704
A3CR1	1901-0376	6	4	DIODE-GEN PRP 35V 50MA DO-35	28480	1901-0376
A3CR2	1901-0376	6		DIODE-GEN PRP 35V 50MA DO-35	28480	1901-0376
A3CR3	1901-0376	6		DIODE-GEN PRP 35V 50MA DO-35	28480	1901-0376
A3CR4	1901-0376	6		DIODE-GEN PRP 35V 50MA DO-35	28480	1901-0376
A3DS1	1990-0660	0	2	LED-LAMP LUM-INT=8MCD IF=20MA-MAX EFR=5V	28480	5082-4597
A3DS2	1990-0660	0		LED-LAMP LUM-INT=8MCD IF=20MA-MAX EFR=5V	28480	5082-4597
A3J1	1250-1594	1	2	CONNECTOR-RF BNC FEM SGL-HOLE-RR 50-OHM	28480	1250-1594
A3J2	1250-1594	1		CONNECTOR-RF BNC FEM SGL-HOLE-RR 50-OHM	28480	1250-1594
A3R1	0698-7097	0	2	RESISTOR 1M 5% .125W CC TC=-600/+1137	01121	BB1055
A3R2	2100-3729	2	2	RESISTOR-VAR CONTROL CCP 20K 10% LTN	01121	WP4H048P203UA
A3R3	0698-7277	6	2	RESISTOR 51.1K 1% .05W F TC=0+-100	24546	C3-1/8-T0-5112-G
A3R4	0698-7194	6	2	RESISTOR 17.8 1% .05W F TC=0+-100	24546	C3-1/8-T0-1788-G
A3R5	0698-7276	5	2	RESISTOR 46.4K 1% .05W F TC=0+-100	24546	C3-1/8-T0-4642-G
A3R6	0698-7259	4	2	RESISTOR 9.09K 1% .05W F TC=0+-100	24546	C3-1/8-T0-9091-G
A3R7	0698-7212	9	2	RESISTOR 100 1% .05W F TC=0+-100	24546	C3-1/8-T0-100R-G
A3R8	1810-0374	1	1	NETWORK-RES 8 SIP1.0K OHM X 4	01121	208R102
A3R9	0757-0472	5	2	RESISTOR 200K 1% .125W F TC=0+-100	24546	C4-1/8-T0-2003-F
A3R10	0698-7259	4		RESISTOR 9.09K 1% .05W F TC=0+-100	24546	C3-1/8-T0-9091-G
A3R11	0698-7212	9		RESISTOR 100 1% .05W F TC=0+-100	24546	C3-1/8-T0-100R-G
A3R12	0698-7277	6		RESISTOR 51.1K 1% .05W F TC=0+-100	24546	C3-1/8-T0-5112-G
A3R13	0698-7276	5		RESISTOR 46.4K 1% .05W F TC=0+-100	24546	C3-1/8-T0-4642-G
A3R14	0698-7097	0		RESISTOR 1M 5% .125W CC TC=-600/+1137	01121	BB1055
A3R15	2100-3729	2		RESISTOR-VAR CONTROL CCP 20K 10% LTN	01121	WP4H048P203UA
A3R16	0757-0472	5		RESISTOR 200K 1% .125W F TC=0+-100	24546	C4-1/8-T0-2003-F
A3R17	0698-7194	6		RESISTOR 17.8 1% .05W F TC=0+-100	24546	C3-1/8-T0-1788-G
A3R18	0698-7188	0	1	RESISTOR 10 1% .05W F TC=0+-100	24546	C3-1/8-T0-10R-G
A3S1	3101-2124	2	10	SWITCH-PB DPDT ALING .25A 115VAC	28480	3101-2124
A3S2	3101-2124	2		SWITCH-PB DPDT ALING .25A 115VAC	28480	3101-2124
A3S3	3101-2124	2		SWITCH-PB DPDT ALING .25A 115VAC	28480	3101-2124
A3S4	3101-2124	2		SWITCH-PB DPDT ALING .25A 115VAC	28480	3101-2124
A3S5	3101-2124	2		SWITCH-PB DPDT ALING .25A 115VAC	28480	3101-2124
A3S6	3101-2124	2		SWITCH-PB DPDT ALING .25A 115VAC	28480	3101-2124
A3S7	3101-2124	2		SWITCH-PB DPDT ALING .25A 115VAC	28480	3101-2124
A3S8	3101-2124	2		SWITCH-PB DPDT ALING .25A 115VAC	28480	3101-2124
A3S9	3101-2124	2		SWITCH-PB DPDT ALING .25A 115VAC	28480	3101-2124
A3S10	3101-2124	2		SWITCH-PB DPDT ALING .25A 115VAC	28480	3101-2124
A3TP1	0360-0124	3	3	CONNECTOR-SGL CONT PIN .04-IN-BSC-SZ RND	28480	0360-0124
A3TP2	0360-0124	3		CONNECTOR-SGL CONT PIN .04-IN-BSC-SZ RND	28480	0360-0124
A3TP3	0360-0124	3		CONNECTOR-SGL CONT PIN .04-IN-BSC-SZ RND	28480	0360-0124
				A3 MISCELLANEOUS PARTS		
	0340-0678	0	2	INSULATOR SLBL-LAC-CMPD	28480	0340-0678
	4040-1462	0	2	STANDOFF-LFD	28480	4040-1462
	05315-20201	1	2	SPACER-POTS	28480	05315-20201
	2950-0035	0	2	NUT-HEX-DBL-CHAM 15/32-32-THD	00000	ORDER BY DESCRIPTION
	2950-0052	0	2	NUT-HEX-DBL-CHAM 1/4-40-THD .062-IN-THK	00000	ORDER BY DESCRIPTION

See introduction to this section for ordering information
*Indicates factory selected value

Table 6-2. Replaceable Parts (Continued)

Reference Designation	HP Part Number	C D	Qty	Description	Mfr Code	Mfr Part Number
A4	05315-60004	6	1	INPUT AMPLIFIER BOARD ASSEMBLY (SERIES 1824)	28480	05315-60004
A4C1	0180-2815	1	3	CAPACITOR-FXD 100UF +-20% 10VDC TA	28480	0180-2815
A4C2	0160-3875	3	2	CAPACITOR-FXD 22PF +-5% 200VDC CER 0+-30	28480	0160-3875
A4C3	0180-2815	1		CAPACITOR-FXD 100UF +-20% 10VDC TA	28480	0180-2815
A4C4	0180-2815	1		CAPACITOR-FXD 100UF +-20% 10VDC TA	28480	0180-2815
A4C5	0160-3877	5	2	CAPACITOR-FXD 100PF +-20% 200VDC CER	28480	0160-3877
A4C6	0160-3879	7	13	CAPACITOR-FXD .01UF +-20% 100VDC CER	28480	0160-3879
A4C7	0160-3879	7		CAPACITOR-FXD .01UF +-20% 100VDC CER	28480	0160-3879
A4C8	0160-3879	7		CAPACITOR-FXD .01UF +-20% 100VDC CER	28480	0160-3879
A4C9	0160-3879	7		CAPACITOR-FXD .01UF +-20% 100VDC CER	28480	0160-3879
A4C10	0160-3879	7		CAPACITOR-FXD .01UF +-20% 100VDC CER	28480	0160-3879
A4C11	0160-3879	7		CAPACITOR-FXD .01UF +-20% 100VDC CER	28480	0160-3879
A4C12	0160-3875	3		CAPACITOR-FXD 22PF +-5% 200VDC CER 0+-30	28480	0160-3875
A4C13	0160-3879	7		CAPACITOR-FXD .01UF +-20% 100VDC CER	28480	0160-3879
A4C14	0160-3879	7		CAPACITOR-FXD .01UF +-20% 100VDC CER	28480	0160-3879
A4C15	0160-3879	7		CAPACITOR-FXD .01UF +-20% 100VDC CER	28480	0160-3879
A4C16	0180-2662	6	2	CAPACITOR-FXD 10UF+-10% 10VDC TA	25088	D4R7C51A10K
A4C17	0160-3879	7		CAPACITOR-FXD .01UF +-20% 100VDC CER	28480	0160-3879
A4C18	0160-3877	5		CAPACITOR-FXD 100PF +-20% 200VDC CER	28480	0160-3877
A4C19	0160-3879	7		CAPACITOR-FXD .01UF +-20% 100VDC CER	28480	0160-3879
A4C20	0180-2662	6		CAPACITOR-FXD 10UF+-10% 10VDC TA	25088	D4R7C51A10K
A4C21	0160-3879	7		CAPACITOR-FXD .01UF +-20% 100VDC CER	28480	0160-3879
A4C22	0160-3879	7		CAPACITOR-FXD .01UF +-20% 100VDC CER	28480	0160-3879
A4CR1	1901-0518	8	2	DIODE-SM SIG SCHOTTKY	28480	1901-0518
A4CR2	1901-0518	8		DIODE-SM SIG SCHOTTKY	28480	1901-0518
A4P1	1251-3768	7	1	CONTACT-CONN U/W-POST-TYPE MALE DPSLR	28480	1251-3768
A4P2	1251-5282	4	1	CONNECTOR 12-PIN M POST TYPE	28480	1251-5282
A4Q1	1854-0345	8	2	TRANSISTOR NPN 2N5179 SI TO-72 PD=200MW	04713	2N5179
A4Q2	1855-0213	1	2	TRANSISTOR-JFET DUAL N-CHAN D-MODE TO-78	28480	1855-0213
A4Q3	1854-0345	8		TRANSISTOR NPN 2N5179 SI TO-72 PD=200MW	04713	2N5179
A4Q4	1855-0213	1		TRANSISTOR-JFET DUAL N-CHAN D-MODE TO-78	28480	1855-0213
A4R1	2100-1984	7	2	RESISTOR-TRMR 100 10% C TOP-ADJ 1-TRN	73138	B2PR100
A4R2	0698-3441	8	3	RESISTOR 215 1% .125W F TC=0+-100	24546	C4-1/8-T0-215R-F
A4R3	0757-0416	7	4	RESISTOR 511 1% .125W F TC=0+-100	24546	C4-1/8-T0-511R-F
A4R4	0698-3449	6	2	RESISTOR 28.7K 1% .125W F TC=0+-100	24546	C4-1/8-T0-2872-F
A4R5	0757-0278	9	2	RESISTOR 1.78K 1% .125W F TC=0+-100	24546	C4-1/8-T0-1781-F
A4R6	0698-7218	5	2	RESISTOR 178 1% .05W F TC=0+-100	24546	C3-1/8-T0-178R-G
A4R7	0698-7228	7	3	RESISTOR 464 1% .05W F TC=0+-100	24546	C3-1/8-T0-464R-G
A4R8				NOT ASSIGNED		
A4R9	0698-7228	7		RESISTOR 464 1% .05W F TC=0+-100	24546	C3-1/8-T0-464R-G
A4R10	0698-7209	4	1	RESISTOR 75 1% .05W F TC=0+-100	24546	C3-1/8-T0-75R0-G
A4R11	0698-3441	8		RESISTOR 215 1% .125W F TC=0+-100	24546	C4-1/8-T0-215R-F
A4R12	0757-0417	8	2	RESISTOR 562 1% .125W F TC=0+-100	24546	C4-1/8-T0-562R-F
A4R13	0698-7228	7		RESISTOR 464 1% .05W F TC=0+-100	24546	C3-1/8-T0-464R-G
A4R14	0757-0401	0	1	RESISTOR 100 1% .125W F TC=0+-100	24546	C4-1/8-T0-101 F
A4R15	0698-3449	6		RESISTOR 28.7K 1% .125W F TC=0+-100	24546	C4-1/8-T0-2872-F
A4R16	0757-0278	9		RESISTOR 1.78K 1% .125W F TC=0+-100	24546	C4-1/8-T0-1781 F
A4R17	1810-0219	3	1	NETWORK-RES 8-STP228.0 044 X 4	01121	208R221
A4R18				NOT ASSIGNED		
A4R19	0698-7218	5		RESISTOR 178 1% .05W F TC=0+-100	24546	C3-1/8-T0-178R-G
A4R20	1810-0203	5	1	NETWORK-RES 8-STP470.0 044 X 7	01121	208A471
A4R21	0757-0439	4	2	RESISTOR 6.81K 1% .125W F TC=0+-100	24546	C4-1/8-T0-6811-F
A4R22	0757-0418	9	2	RESISTOR 619 1% .125W F TC=0+-100	24546	C4-1/8-T0-619R-F
A4R23	0757-0418	9		RESISTOR 619 1% .125W F TC=0+-100	24546	C4-1/8-T0-619R-F
A4R24	0757-0283	6	2	RESISTOR 2K 1% .125W F TC=0+-100	24546	C4-1/8-T0-2001 F
A4R25	0757-0416	7		RESISTOR 511 1% .125W F TC=0+-100	24546	C4-1/8-T0-511R-F
A4R26	0757-0416	7		RESISTOR 511 1% .125W F TC=0+-100	24546	C4-1/8-T0-511R-F
A4R27	0757-0421	4	2	RESISTOR 825 1% .125W F TC=0+-100	24546	C4-1/8-T0-825R-F
A4R28	0698-3441	8		RESISTOR 215 1% .125W F TC=0+-100	24546	C4-1/8-T0-215R-F
A4R29	0757-0439	4		RESISTOR 6.81K 1% .125W F TC=0+-100	24546	C4-1/8-T0-6811-F
A4R30	0757-0417	8		RESISTOR 562 1% .125W F TC=0+-100	24546	C4-1/8-T0-562R-F
A4R31	0757-0421	4		RESISTOR 825 1% .125W F TC=0+-100	24546	C4-1/8-T0-825R-F
A4R32	2100-1984	7		RESISTOR-TRMR 100 10% C TOP-ADJ 1-TRN	73138	B2PR100
A4R33	0757-0416	7		RESISTOR 511 1% .125W F TC=0+-100	24546	C4-1/8-T0-511R-F
A4R34	0757-0283	6		RESISTOR 2K 1% .125W F TC=0+-100	24546	C4-1/8-T0-2001 F
A4TP1	0360-0124	3	1	CONNECTOR-SGL CONT PIN .04-IN-BSC-SZ RND	28480	0360-0124
A4U1	1858-0040	8	1	TRANSISTOR ARRAY 16-PIN PLSTC DIP	0192B	CA3127E
A4U2	1826-0426	7	1	IC COMPARATOR HS DUAL 14-DIP-C PKG	34335	AM687ADJ
A4U3	1821-0001	4	1	TRANSISTOR ARRAY 14-PIN PLSTC DIP	0192B	CA3046

See introduction to this section for ordering information
*Indicates factory selected value

Table 6-2. Replaceable Parts (Continued)

Reference Designation	HP Part Number	C D	Qty	Description	Mfr Code	Mfr Part Number
A5	05315-60005	7	1	SUPPORT BOARD	28480	05315-60005
A5P1	1251-3768	7	2	CONTACT-CONN U/W POST-TYPE MALE DP6LDR	28480	1251-3768
A5P2	1251-3768	7		CONTACT-CONN U/W POST-TYPE MALE DP6LDR	28480	1251-3768
A13	05315-60016	0	1	REFERENCE OSCILLATOR ASSEMBLY (STANDARD) (SERIES 2120)	28480	05315-60016
A13C1	0121-0059	7	1	CAPACITOR-V TRMP-CER 2-8PF 350V PC-MTG	52763	304324 2/8PF NPO
A13C2*	0160-3875	3	1	CAPACITOR-FXD 22PF +-5% 200VDC CER 94-30	28480	0160-3875
A13C3	0121-0105	4	1	CAPACITOR-V TRMP-CER 9-35PF 200V PC-MTG	52763	304324 9/35PF N650
A13C4	0160-4554	7	2	CAPACITOR-FXD .010F +-20% 50VDC CER	28480	0160-4554
A13C5	0160-4389	6	1	CAPACITOR-FXD 108PF +-5PF 200VDC CER	51642	200-200-NP0-101J
A13C6	0160-4481	9	1	CAPACITOR-FXD 270PF +-5% 100VDC CER	51642	150-100-NP0-271J
A13C7	0160-4554	7		CAPACITOR-FXD .010F +-20% 50VDC CER	28480	0160-4554
A13L1	9140-0210	1	1	INDUCTOR RF-CR-MLD 100UH 5% .166DX.385LG	28480	9140-0210
A13P1	1251-4510	9	1	CONNECTOR 6-PIN M POST TYPE	28480	1251-4510
A13Q1	1854-0477	7	2	TRANSISTOR NPN 2N2222A SI TO-18 PD=500MW	04713	2N2222A
A13Q2	1854-0477	7		TRANSISTOR NPN 2N2222A SI TO-18 PD=500MW	04713	2N2222A
A13R1	0757-0199	3	2	RESISTOR 21.5K 1% .125W F TC=0+-100	24546	C4-1/8-T0-2152-F
A13R2	0757-0199	3		RESISTOR 21.5K 1% .125W F TC=0+-100	24546	C4-1/8-T0-2152-F
A13R3	0698-3443	0	1	RESISTOR 287 1% .125W F TC=0+-100	24546	C4-1/8-T0-287R-F
A13R4	0757-0280	3	3	RESISTOR 1K 1% .125W F TC=0+-100	24546	C4-1/8-T0-1001-F
A13R5	0757-0280	3		RESISTOR 1K 1% .125W F TC=0+-100	24546	C4-1/8-T0-1001-F
A13R6	0757-0280	3		RESISTOR 1K 1% .125W F TC=0+-100	24546	C4-1/8-T0-1001-F
A13Y1	0410-0423	2	1	CRYSTAL-QUARTZ 16.000 MHZ	28480	0410-0423
	1400-0957	7	2	BRACKET	28480	1400-0957

See introduction to this section for ordering information
*Indicates factory selected value

Table 6-2. Replaceable Parts (Continued)

Reference Designation	HP Part Number	C D	Qty	Description	Mfr Code	Mfr Part Number
5315A CHASSIS PARTS						
F1	2110-0318	0	1	FUSE .125A 250V TD 1.25X.15 UL	28915	313 125
F1	2110-0201	0	1	FUSE .25A 250V TD 1.25X.25 UL	28915	313 250
MP1	4040-1126	3	1	SHELL -TOP	28480	4040-1126
MP2	4040-1463	1	1	SHELL -BOTTOM	28480	4040-1463
MP3	5040-8058	5	1	HANDLE	28480	5040-8058
MP4	5040-8044	9	4	SPACER	28480	5040-8044
MP5	05315-40002	2	1	WINDOW	28480	05315-40002
MP6	05315-00026	6	1	PANEL-FRONT EXCEPT OPTION 003	28480	05315-00026
MP7	5040-7223	4	2	FOOT	28480	5040-7223
T1	9100-4058	9	1	TRANSFORMER-POWER	28480	9100-4058
W1	8120-1378	1	1	CABLE ASSY 18AWG 3-CNDCT JGK-JKT	28480	8120-1378
MISCELLANEOUS PARTS						
	0370-1005	2	3	KNOB-BASE-PTR 3/8 JGK .125-IN-ID	28480	0370-1005
	0370-2486	5	8	PUSHBUTTON 230X.390X.397 IN H: JADE	28480	0370-2486
	0370-2917	7	1		28480	0370-2917
	0370-2872	3	1	PUSHBUTTON-WHITE	28480	0370-2872
	7120-5370	0	2	LABEL-HANDLE	28480	7120-5370
	7120-7425	0	1	LABEL-5315A SERIAL	28480	7120-7425
	7120-7426	1	1	LABEL-5315A VOLTAGE	28480	7120-7426
	7120-7475	0	1	LABEL-5315A CAUTION	28480	7120-7475
	7120-7489	6	1	LABEL-INFO	28480	7120-7489
	5040-8816	3	10	BUTTONS SQUARE	28480	5040-8816

See introduction to this section for ordering information
*Indicates factory selected value

Table 6-2. Replaceable Parts (Continued)

Reference Designation	HP Part Number	C D	Qty	Description	Mfr Code	Mfr Part Number
5315B CHASSIS PARTS						
AB	0960-0443	1	1	LINE MODULE-FILTERFD	28480	0960-0443
F1	2110-0318	0	1	FUSE .125A 250V TD 1.25X.25 UL	75915	313.125
F1	2110-0201	0	1	FUSE .25A 250V TD 1.25X.25 UL	75915	313.250
JB	1250-0083	1	1	CONNECTOR-RF BNC FEM SGL-HOLE-FR 50-OHM	28480	1250-0083
MP8	5060-9963	5	1	COVER-BOTTOM	28480	5060-9963
MP9	5040-7201	8	4	FOOT(STANDARD)	28480	5040-7201
MP10	1460-1345	5	2	TILT STAND SST	28480	1460-1345
MP11	5060-9802	1	1	STRAP-HANDLE	28480	5060-9802
	5040-7219	8	1	STRAP-HANDLE, CAP-FRONT	28480	5040-7219
	5040-7220	1	1	STRAP-HANDLE, CAP-REAR	28480	5040-7220
	5040-8816	3		BUTTONS (SQUARE)	28480	5040-8816
MP12	5001-0418	3	1	COVER -TOP	28480	5001-0418
MP13	05315-00025	5	1	PANEL-REAR	28480	05315-00025
MP14	5020-8814	9	1	FRAME-REAR	28480	5020-8814
MP15	05315-00010	8	1	SUPPORT-REAR	28480	05315-00010
MP16	5040-7203	8	1	TRIM-TOP 1/2	28480	5040-7203
MP17	5020-8813	8	1	FRAME-FRONT	28480	5020-8813
MP18	5001-0438	7	2	TRIM-SIDE	28480	5001-0438
MP19	5020-8830	9	1	SIDE STRUT-RIGHT	28480	5020-8830
MP20	05315-40003	3	1	WINDOW	28480	05315-40003
MP21	05315-00028	8	1	PANEL-FRONT (EXCEPT OPTION 003)	28480	05315-00028
MP28	5020-8885	4	1	SIDE STRUT-LEFT	28480	5020-8885
MP29	0403-0373	2		GUIDE, PC BOARD	28480	0403-0373
MISCELLANEOUS PARTS						
T1	05315-80001	5	1	TRANSFORMER, MODIFIED	28480	05315-80001
W1	8120-1378	1	1	CABLE ASSY 18 AWG 3-CNDCT JGK-JKT	28480	8120-1378
	0370-0606	7	16	BEZEL-PUSHBUTTON (SQUARE)	28480	0370-0606
	0370-0914	0	9	BEZEL-PUSHBUTTON (RECT)	28480	0370-0914
	0370-1005	2	3	KNOB-BASE-PTR 3/8 JGK .125-IN-ID	28480	0370-1005
	0370-2486	5	8	PUSHBUTTON .230X.390X.397 IN H: JADE	28480	0370-2486
	0370-2917	7	1	PUSHBUTTON .230X.390X.397 IN H	28480	0370-2917
	0370-2872	3	1	PUSHBUTTON-WHITE	28480	0370-2872
	0510-1152	8	8	RETAINER-PUSH ON	28480	0510-1152
	0590-0639	2	1	NUT-SHMET-FLT 10-32-THD STL	28480	0590-0639
	5040-8816	3	12	BUTTONS (SQUARE)	28480	5040-8816
	7120-7872	1	1	LABEL-INFO (POWER)	28480	7120-7872
	7120-7489	6	1	LABEL-INFO	28480	7120-7489

See introduction to this section for ordering information
*Indicates factory selected value

Table 6-3. Option 001 Replaceable Parts

Reference Designation	HP Part Number	C D	Qty	Description	Mfr Code	Mfr Part Number
A7	05315-60007	9	1	TCXO ASSEMBLY-OPTION 001 (SERIES 1624)	28480	05315-60007
A7C1	0180-0562	1	1	CAPACITOR-FXD 33UF+-20% 10VDC TA	56289	196D336X0010RA1
A7R1	0757-0280	3	1	RESISTOR 1K 1% .125W F TC=0+-100	24546	C4-1/8-T0-1001-F
A7R2	0698-3444	1	1	RESISTOR 316 1% .125W F TC=0+-100	24546	C4-1/8-T0-316R-F
A7Y1	0960-0394	1	1	CRYSTAL OSCILLATOR - TCXO	28480	0960-0394
				A7 MISCELLANEOUS PARTS		
	1251-4510	9	1	CONNECTOR 6-PIN M POST TYPE	28480	1251-4510
	1400-0957	7	2	BRACKET-RTANG .475-LG X .183-LG .25-WD	28480	1400-0957

See introduction to this section for ordering information
*Indicates factory selected value

Table 6-4. Option 002 Replaceable Parts

Reference Designation	HP Part Number	C D	Qty	Description	Mfr Code	Mfr Part Number
A6	05315-60015	9	1	BATTERY CHARGER ASSEMBLY—OPTION 002 5315A ONLY; SERIES 2120	28480	05315-60015
A6C1	0180-2815	1	1	CAPACITOR-FXD .100UF+-20% 10VDC TA	28480	0180-2815
A6C2	0160-0576	5	10	CAPACITOR-FXD .1UF +-20% 50VDC CER	28480	0160-0576
A6C3	0160-0576	5		CAPACITOR-FXD .1UF +-20% 50VDC CER	28480	0160-0576
A6C4	0180-2821	9	3	CAPACITOR-FXD 220UF+-20% 35VDC TA	28480	0180-2821
A6C5	0160-4511	6	1	CAPACITOR-FXD 220UF +-5% 200VDC CER	51642	200-200-NP0-221J
A6C6	0160-0576	5		CAPACITOR-FXD .1UF +-20% 50VDC CER	28480	0160-0576
A6C7	0160-0576	5		CAPACITOR-FXD .1UF +-20% 50VDC CER	28480	0160-0576
A6C8				NOT ASSIGNED		
A6C9	0160-0576	5		CAPACITOR-FXD .1UF +-20% 50VDC CER	28480	0160-0576
A6C10	0180-2686	4	1	CAPACITOR-FXD 470UF+100-10% 25VDC AL	00853	301AER471U025B
A6C11	0180-2821	9		CAPACITOR-FXD 220UF+-20% 35VDC TA	28480	0180-2821
A6C12	0160-0576	5		CAPACITOR-FXD .1UF +-20% 50VDC CER	28480	0160-0576
A6C13	0160-0576	5		CAPACITOR-FXD .1UF +-20% 50VDC CER	28480	0160-0576
A6C14	0180-2821	9		CAPACITOR-FXD 220UF+-20% 35VDC TA	28480	0180-2821
A6C15	0180-0562	1	1	CAPACITOR-FXD 33UF+-20% 10VDC TA	56289	1960336X0010KA1
A6C16	0160-0576	5		CAPACITOR-FXD .1UF +-20% 50VDC CER	28480	0160-0576
A6C17	0160-0576	5		CAPACITOR-FXD .1UF +-20% 50VDC CER	28480	0160-0576
A6CR1	1901-0734	0	1	DIODE-PWR RECT 1N5818 30V 1A	04713	1N5818
A6CR2	1901-0050	3	6	DIODE-SWITCHING 80V 200MA 2NS DO-35	28480	1901-0050
A6CR3	1901-0050	3		DIODE-SWITCHING 80V 200MA 2NS DO-35	28480	1901-0050
A6CR4	1901-0050	3		DIODE-SWITCHING 80V 200MA 2NS DO-35	28480	1901-0050
A6CR5	1901-0691	0	1	DIODE-PWR RECT 100V 3A 200NS	03508	A115A
A6CR6	1901-0050	3		DIODE-SWITCHING 80V 200MA 2NS DO-35	28480	1901-0050
A6CR7	1901-0460	9	1	DIODE-STABISTOR 30V 150MA DO-7	28480	1901-0460
A6CR8	1901-0676	9	1	DIODE-SCHOTTKY 20V 5A	28480	1901-0676
A6CR8	1901-0782	0		DIODE-SCHOTTKY 1N5821 30V 3A ALTERNATE	04713	1N5821
A6CR9	1901-0050	3		DIODE-SWITCHING 80V 200MA 2NS DO-35	28480	1901-0050
A6CR10	1901-0050	3		DIODE-SWITCHING 80V 200MA 2NS DO-35	28480	1901-0050
A6F1	2110-0381	7	1	FUSE 3A 250V TD 1.25X.25	28480	2110-0381
A6J1	1251-5370	1	1	CONNECTOR 11-PIN M POST TYPE	28480	1251-5370
A6L1	9140-0320	4	1	INDUCTOR 75UH 8% .7DX.6LG	28480	9140-0320
A6L2	9100-1788	6	1	CHOKER WIDE BAND ZMAX=600 OHM 180 MHZ	02114	VK200 20/4B
A6Q1	1853-0363	8	2	TRANSISTOR PNP SI PD=50W FT=20MHZ	03508	X45H281
A6Q2	1853-0363	8		TRANSISTOR PNP SI PD=50W FT=20MHZ	03508	X45H281
A6Q3	1854-0477	7	3	TRANSISTOR NPN 2N2222A SI TO-18 PD=500MW	04713	2N2222A
A6Q4	1853-0036	2	3	TRANSISTOR PNP SI PD=310MW FT=250MHZ	28480	1853-0036
A6Q5	1853-0036	2		TRANSISTOR PNP SI PD=310MW FT=250MHZ	28480	1853-0036
A6Q6	1853-0036	2		TRANSISTOR PNP SI PD=310MW FT=250MHZ	28480	1853-0036
A6Q7	1854-0477	7		TRANSISTOR NPN 2N2222A SI TO-18 PD=500MW	04713	2N2222A
A6Q8	1854-0477	7		TRANSISTOR NPN 2N2222A SI TO-18 PD=500MW	04713	2N2222A
A6R1	0757-0398	4	1	RESISTOR 75 1% .125W F TC=0+-100	24546	C4-1/8-T0-75R0-F
A6R2	0698-3438	3	1	RESISTOR 147 1% .125W F TC=0+-100	24546	C4-1/8-T0-147R-F
A6R3	0812-0021	8	1	RESISTOR .47 5% 3W PW TC=0+-90	91637	CU2B1-3-T2-47/100-J
A6R4	0757-0276	7	1	RESISTOR 61.9 1% .125W F TC=0+-100	24546	C4-1/8-T0-6192-F
A6R5	0757-0280	3	4	RESISTOR 1K 1% .125W F TC=0+-100	24546	C4-1/8-T0-1001-F
A6R6	0757-0442	9	5	RESISTOR 10K 1% .125W F TC=0+-100	24546	C4-1/8-T0-1002-F
A6R7	0757-0401	0	1	RESISTOR 100 1% .125W F TC=0+-100	24546	C4-1/8-T0-101-F
A6R8	0757-0290	5	1	RESISTOR 6.19K 1% .125W F TC=0+-100	19701	MF4C1/8-T0-6191-F
A6R9	0757-0274	5	1	RESISTOR 1.21K 1% .125W F TC=0+-100	24546	C4-1/8-T0-1211-F
A6R10	0757-0280	3		RESISTOR 1K 1% .125W F TC=0+-100	24546	C4-1/8-T0-1001-F
A6R11	0698-8822	9	1	RESISTOR 6.81 1% .125W F TC=0+-100	28480	0698-8822
A6R12	0757-0465	6	1	RESISTOR 100K 1% .125W F TC=0+-100	24546	C4-1/8-T0-1003-F
A6R13	0757-0441	8	1	RESISTOR 8.25K 1% .125W F TC=0+-100	24546	C4-1/8-T0-8251-F
A6R14	2100-2497	9	2	RESISTOR-TRMR 2K 10% C TOP-ADJ 1-TRN	73138	82PR2K
A6R15	2100-2497	9		RESISTOR-TRMR 2K 10% C TOP-ADJ 1-TRN	73138	82PR2K
A6R16	0757-0280	3		RESISTOR 1K 1% .125W F TC=0+-100	24546	C4-1/8-T0-1001-F
A6R17	0757-0438	3	2	RESISTOR 5.11K 1% .125W F TC=0+-100	24546	C4-1/8-T0-5111-F
A6R18	0757-0438	3		RESISTOR 5.11K 1% .125W F TC=0+-100	24546	C4-1/8-T0-5111-F
A6R19	0757-0419	0	1	RESISTOR 681 1% .125W F TC=0+-100	24546	C4-1/8-T0-681R-F
A6R20	0811-1827	2	1	RESISTOR .1 10% 3W PW TC=0+-90	28480	0811-1827
A6R21	0757-0283	6	1	RESISTOR 2K 1% .125W F TC=0+-100	24546	C4-1/8-T0-2001-F
A6R22	0757-0442	9		RESISTOR 10K 1% .125W F TC=0+-100	24546	C4-1/8-T0-1002-F
A6R23	0757-0421	4	1	RESISTOR 825 1% .125W F TC=0+-100	24546	C4-1/8-T0-825R-F
A6R24	0757-0442	9		RESISTOR 10K 1% .125W F TC=0+-100	24546	C4-1/8-T0-1002-F
A6R25	0757-0199	3	2	RESISTOR 21.5K 1% .125W F TC=0+-100	24546	C4-1/8-T0-2152-F

See introduction to this section for ordering information
*Indicates factory selected value

Table 6-4. Option 002 Replaceable Parts (Continued)

Reference Designation	HP Part Number	C D	Qty	Description	Mfr Code	Mfr Part Number
A6R26	0757-0442	9		RESISTOR 10K 1% .125W F TC=0+-100	24546	C4-1/8-T0-1002-F
A6R27	0757-1093	8	1	RESISTOR 3K 1% .125W F TC=0+-100	24546	C4-1/8-T0-3001-F
A6R28	0757-0280	3		RESISTOR 1K 1% .125W F TC=0+-100	24546	C4-1/8-T0-1001-F
A6R29	0757-0472	5	1	RESISTOR 200K 1% .125W F TC=0+-100	24546	C4-1/8-T0-2003-F
A6R30	0698-3155	1	1	RESISTOR 4.64K 1% .125W F TC=0+-100	24546	C4-1/8-T0-4641-F
A6R31	0757-0199	3		RESISTOR 21.5K 1% .125W F TC=0+-100	24546	C4-1/8-T0-2152-F
A6R32	0698-3160	8	1	RESISTOR 31.6K 1% .125W F TC=0+-100	24546	C4-1/8-T0-3162-F
A6R33	0757-0442	9		RESISTOR 10K 1% .125W F TC=0+-100	24546	C4-1/8-T0-1002-F
A6R34	0757-0407	6	1	RESISTOR 200 1% .125W F TC=0+-100	24546	C4-1/8-T0-201-F
A6R35	0698-3156	2	1	RESISTOR 14.7K 1% .125W F TC=0+-100	24546	C4-1/8-T0-1472-F
A6R36	0757-0462	3	1	RESISTOR 75K 1% .125W F TC=0+-100	24546	C4-1/8-T0-7502-F
A6R37	0757-0447	4	1	RESISTOR 16.2K 1% .125W F TC=0+-100	24546	C4-1/8-T0-1622-F
A6R38	0811-3117	7	1	RESISTOR 12 1% 7W PW TC=0+-20	28480	0811-3117
A6RT1	0837-0159	5	1	THERMISTOR-33K OHM	01295	TM 1/8 333K
A6TP1	1251-0600	0		CONNECTOR-SGL CONT PIN 1.14-MM-BSC-SZ 5Q	28480	1251-0600
A6TP2	1251-0600	0		CONNECTOR-SGL CONT PIN 1.14-MM-BSC-SZ 5Q	28480	1251-0600
A6TP3	1251-0600	0		CONNECTOR-SGL CONT PIN 1.14-MM-BSC-SZ 5Q	28480	1251-0600
A6TP4	1251-0600	0		CONNECTOR-SGL CONT PIN 1.14-MM-BSC-SZ 5Q	28480	1251-0600
A6TP5	1251-0600	0		CONNECTOR-SGL CONT PIN 1.14-MM-BSC-SZ 5Q	28480	1251-0600
A6TP6	1251-0600	0		CONNECTOR-SGL CONT PIN 1.14-MM-BSC-SZ 5Q	28480	1251-0600
A6TP7	1251-0600	0		CONNECTOR-SGL CONT PIN 1.14-MM-BSC-SZ 5Q	28480	1251-0600
A6TP8	1251-0600	0		CONNECTOR-SGL CONT PIN 1.14-MM-BSC-SZ 5Q	28480	1251-0600
A6U1	1826-0450	7	1	IC V RGLTR 14-DIP-P	01295	TL497CN
A6U2	1826-0346	0	1	IC OP AMP GP DUAL 8-DIP-P PKG	27014	LM358N
A6U3	1826-0544	0	1	V REF 8-DIP-C	04713	MC1403U
A6U4	1826-0412	1	2	IC COMPARATOR PRCN DUAL 8-DIP-P PKG	27014	LM393N
A6U5	1820-1600	9	1	IC SCHMITT-TRIG CMOS NAND QUAD 2-INP	0192B	CD4093BE
A6U6	1826-0412	1		IC COMPARATOR PRCN DUAL 8-DIP-P PKG	27014	LM393N
A6XF1	2110-0269	0	2	FUSEHOLDER-CLIP TYPE .25D-FUSE	28480	2110-0269
	1251-0600	0	11	CONNECTOR-SGL CONT PIN 1.14-MM-BSC-SZ 5Q	28480	1251-0600
5315A CHASSIS PARTS						
BT1	1420-0253	8	1	BATTERY 6V 5A-HR PB-ACID QDISC		
MP22	05315-00005	1	1	CLAMP-BATTERY		
MP23	05315-00006	2	1	DECK-BATTERY		
MP24	0510-0585	9	1	RETAINER-PUSH ON RND EXT .383-IN-DIA		
MP25	05315-00014	2	1	CLIP-GROUNDING		
W2	05315-60102	5	1	CABLE ASSEMBLY-LEAD (RED)		
W3	05315-60103	6	1	CABLE ASSEMBLY-LEAD (BLACK)		
W4	05315-60101	4	1	CABLE ASSEMBLY-BATTERY		

See introduction to this section for ordering information
*Indicates factory selected value

Table 6-5. Option 003 Replaceable Parts

Reference Designation	HP Part Number	C D	Qty	Description	Mfr Code	Mfr Part Number
A9	05315-60009 05315-60009	1 1	1	FREQUENCY BOARD ASSEMBLY - OPTION 003 SERIES 1928	28480 28480	05315-60009 05315-60009
A9C1	0160-0576	5	16	CAPACITOR-FXD .10UF +-20% 50VDC CER	28480	0160-0576
A9C2	0180-2662	6	4	CAPACITOR-FXD 100UF+-10% 10VDC TA	25088	D4R7GS1A10K
A9C4	0160-0576	5		CAPACITOR-FXD .10UF +-20% 50VDC CER	28480	0160-0576
A9C5	0160-0576	5		CAPACITOR-FXD .10UF +-20% 50VDC CER	28480	0160-0576
A9C6	0160-0576	5		CAPACITOR-FXD .10UF +-20% 50VDC CER	28480	0160-0576
A9C7	0180-2662	6		CAPACITOR-FXD 100UF+-10% 10VDC TA	25088	D4R7GS1A10K
A9C8	0180-2662	6		CAPACITOR-FXD 100UF+-10% 10VDC TA	25088	D4R7GS1A10K
A9C9	0160-3878	6	1	CAPACITOR-FXD 1000PF +-20% 100VDC CER	28480	0160-3878
A9C10	0160-0576	5		CAPACITOR-FXD .10UF +-20% 50VDC CER	28480	0160-0576
A9C11	0160-0576	5		CAPACITOR-FXD .10UF +-20% 50VDC CER	28480	0160-0576
A9C12	0160-0576	5		CAPACITOR-FXD .10UF +-20% 50VDC CER	28480	0160-0576
A9C13	0160-0576	5		CAPACITOR-FXD .10UF +-20% 50VDC CER	28480	0160-0576
A9C14	0160-0576	5		CAPACITOR-FXD .10UF +-20% 50VDC CER	28480	0160-0576
A9C15	0160-0576	5		CAPACITOR-FXD .10UF +-20% 50VDC CER	28480	0160-0576
A9C16	0160-0576	5		CAPACITOR-FXD .10UF +-20% 50VDC CER	28480	0160-0576
A9C17	0160-0576	5		CAPACITOR-FXD .10UF +-20% 50VDC CER	28480	0160-0576
A9C18	0160-0576	5		CAPACITOR-FXD .10UF +-20% 50VDC CER	28480	0160-0576
A9C19	0160-0576	5		CAPACITOR-FXD .10UF +-20% 50VDC CER	28480	0160-0576
A9C20	0180-2662	6		CAPACITOR-FXD 100UF+-10% 10VDC TA	25088	D4R7GS1A10K
A9C21	0160-0127	2	1	CAPACITOR-FXD 10UF +-20% 25VDC CER	28480	0160-0127
A9C22	0160-0576	5		CAPACITOR-FXD .10UF +-20% 50VDC CER	28480	0160-0576
A9C23	0160-0576	5		CAPACITOR-FXD .10UF +-20% 50VDC CER	28480	0160-0576
A9CR1	1901-0535	9	4	DIODE-SM SIG SCHOTTKY	28480	1901-0535
A9CR2	1901-0535	9		DIODE-SM SIG SCHOTTKY	28480	1901-0535
A9CR3	1901-0050	3	2	DIODE-SWITCHING 80V 200MA 2NS DO-35	28480	1901-0050
A9CR4	1901-0050	3		DIODE-SWITCHING 80V 200MA 2NS DO-35	28480	1901-0050
A9CR5	1902-0041	4	1	DIODE-ZNR 5.11V 5% DO-35 PD=.4W	28480	1902-0041
A9CR6	1901-0535	9		DIODE-SM SIG SCHOTTKY	28480	1901-0535
A9CR7	1901-0535	9		DIODE-SM SIG SCHOTTKY	28480	1901-0535
A9CR8	1902-0551	1	1	DIODE-ZNR 6.19V 5% DO-35 PD=1W TC=+.022%	28480	1902-0551
A9F1	2110-0301	1	1	FUSE .125A 125V .281X.093	28480	2110-0301
A9J1	05305-20105	2	1	INSULATOR-TEFLON	28480	05305-20105
A9L1	9100-1788	6	2	CHOKE-WIDE BAND ZMAX=680 OHMS 180 MHZ	02114	VK200 20/48
A9L2	9100-1788	6		CHOKE-WIDE BAND ZMAX=680 OHMS 180 MHZ	02114	VK200 20/48
A9L3	9100-2272	5	3	INDUCTOR RF-CH-MLD 47UH 10% .105DX.26LG	28480	9100-2272
A9L4	9100-2272	5		INDUCTOR RF-CH-MLD 47UH 10% .105DX.26LG	28480	9100-2272
A9L5	9100-2272	5		INDUCTOR RF-CH-MLD 47UH 10% .105DX.26LG	28480	9100-2272
A9P1	1251-1556 1251-5621	7 5	24 1	CONNECTOR-SGL CONT SKT .018-IN-BSC-SZ CONNECTOR 12-PIN F POST TYPE	28480 28480	1251-1556 1251-5621
A9Q1	1853-0281	9	1	TRANSISTOR PNP 2N2907A SI TO-18 PD=400MW	04713	2N2907A
A9Q2	1855-0420	2	2	TRANSISTOR J-FET 2N4391 N-CHAN D-MODE	01295	2N4391
A9Q3	1855-0420	2		TRANSISTOR J-FET 2N4391 N-CHAN D-MODE	01295	2N4391
A9R1	0698-7234	5	5	RESISTOR 825 1% .05W F TC=0+-100	24546	C3-1/8-T0-825R-G
A9R2	0698-7234	5		RESISTOR 825 1% .05W F TC=0+-100	24546	C3-1/8-T0-825R-G
A9R3	0698-7205	0	2	RESISTOR 51.1 1% .05W F TC=0+-100	24546	C3-1/8-T00-51R1-G
A9R4	0698-7234	5		RESISTOR 825 1% .05W F TC=0+-100	24546	C3-1/8-T0-825R-G
A9R5	0698-7205	0		RESISTOR 51.1 1% .05W F TC=0+-100	24546	C3-1/8-T00-51R1-G
A9R6	0698-7258	3	1	RESISTOR 9.25K 1% .05W F TC=0+-100	24546	C3-1/8-T0-8251-G
A9R7	0698-7196	8	2	RESISTOR 21.5 1% .05W F TC=0+-100	24546	C3-1/8-T00-21R5-G
A9R8	0698-7196	8		RESISTOR 21.5 1% .05W F TC=0+-100	24546	C3-1/8-T00-21R5-G
A9R9	2100-2061	3	4	RESISTOR-TRMR 200 10% C TOP-ADJ 1-TRN	73138	82PR200
A9R10	0698-7276	5	2	RESISTOR 46.4K 1% .05W F TC=0+-100	24546	C3-1/8-T0-4642-G
A9R11	0698-7250	5	1	RESISTOR 3.83K 1% .05W F TC=0+-100	24546	C3-1/8-T0-3831-G
A9R12	0698-7269	6	1	RESISTOR 23.7K 1% .05W F TC=0+-100	24546	C3-1/8-T0-2372-G
A9R13	0698-7243	6	1	RESISTOR 1.96K 1% .05W F TC=0+-100	24546	C3-1/8-T0-1961-G
A9R14	2100-2061	3		RESISTOR-TRMR 200 10% C TOP-ADJ 1-TRN	73138	82PR200
A9R15	0698-7234	5		RESISTOR 825 1% .05W F TC=0+-100	24546	C3-1/8-T0-825R-G
A9R16	2100-2061	3		RESISTOR-TRMR 200 10% C TOP-ADJ 1-TRN	73138	82PR200
A9R17	0698-7212	9	1	RESISTOR 100 1% .05W F TC=0+-100	24546	C3-1/8-T0-100R-G
A9R18	2100-2061	3		RESISTOR-TRMR 200 10% C TOP-ADJ 1-TRN	73138	82PR200
A9R19	0698-7234	5		RESISTOR 825 1% .05W F TC=0+-100	24546	C3-1/8-T0-825R-G
A9R20	0698-7276	5		RESISTOR 46.4K 1% .05W F TC=0+-100	24546	C3-1/8-T0-4642-G
A9U1	1826-0589	3	1	IC TO-B PKG	28480	1826-0589
A9U2	1826-0138	8	1	IC COMPARATOR GP QUAD 14-DIP-P PKG	01295	LM339N
A9U3	1820-2171	1	1	IC PRESER ECL	28480	1820-2171
A9W1	05315-60104	7	1	CABLE ASSEMBLY-FREQUENCY C	28480	05315-60104
A9W2	05315-60106	9	1	CABLE ASSEMBLY-RESET	28480	05315-60106

See introduction to this section for ordering information
*Indicates factory selected value

Table 6-5. Option 003 Replaceable Parts (Continued)

Reference Designation	HP Part Number	C D	Qty	Description	Mfr Code	Mfr Part Number
				A9 MISCELLANEOUS PARTS		
	0360-0124	3	5	CONNECTOR-SGL CONT PIN .04-IN-BCC-S7 RND	28480	0360-0124
	1205-0375	9	1	HEAT SINK SGL TO-B-C5	05820	211-CB
	05305-60205	7	1	CONNECTOR-SPECIAL BNC	28480	05305-60205
	05305-20104	1	1	CONNECTOR-BODY	28480	05305-20104
	0590-0030	5	1	NUT-HEX-DEB-CHAM 1/2-32-THD .094-IN-THK	00000	ORDER BY DESCRIPTION
	2190-0124	4	1	WASHER-LK INTL T NO. 10 .195-IN-ID	28480	2190-0124
	05305-60206	8	1	MINI-CONNECTOR	28480	05305-60206
				5315A CHASSIS PARTS		
MP6	05315-00027	7	1	PANEL-FRONT	28480	05315-00027
				5315B CHASSIS PARTS		
MP21	05315-00029	9	1	PANEL-FRONT	28480	05315-00029

See introduction to this section for ordering information
*Indicates factory selected value

Table 6-6. 5315A Option 004 Replaceable Parts

Reference Designation	HP Part Number	C D	Qty	Description	Mfr Code	Mfr Part Number
A14	05315-60017	1	1	REFERENCE OSCILLATOR ASSEMBLY(OPT. 004) (SERIES 2120)	28480	05315-60017
A14C1	0160-4554	7	2	CAPACITOR-FXD .01UF +-20% 50VDC CER	28480	0160-4554
A14C2	0160-4554	7	1	CAPACITOR-FXD .01UF +-20% 50VDC CER	28480	0160-4554
A14C3	0180-2662	6	1	CAPACITOR-FXD 10UF+-10% 10VDC TA	25088	D4R7GS1A10K
A14C4	0180-0418	6	1	CAPACITOR-FXD 1UF+-20% 35VDC TA	28480	0180-0418
A14C5	0160-4511	6	1	CAPACITOR-FXD 220PF +-5% 20VDC CER	51642	200-200-NP0-221J
A14CR1	1901-0731	7	1	DIODE-PWR RECT 400V 1A	28480	1901-0731
A14CR2	1902-3059	8	1	DIODE-ZNR 3.83V 5% D0-35 PD=.4W	28480	1902-3059
A14P1				NOT ASSIGNED		
A14P2	1251-4510	9		CONNECTOR -6 PIN, MALE	28480	1251-4510
A14Q1	1853-0363	8	1	TRANSISTOR PNP SI PD=50W FT=20MHZ	03508	X4542B1
	0340-0468	6	1	INSULATOR-XSTR NYLON	28480	0340-0468
	0340-0864	6	1	INSULATOR-XSTR THRM-CNDCT	28480	0340-0864
	1205-0219	0	1	HEAT SINK SGL TO-66-CS	28480	1205-0219
A14Q2	1854-0477	7	1	TRANSISTOR NPN 2N2222A SI TO-18 PD=500MW	04713	2N2222A
A14R1	2100-0568	1	1	RESISTOR-TRMR 100 10% C TOP-ADJ 1-TRN	28480	2100-0568
A14R2	0757-0401	8	1	RESISTOR 100 1% .125W F TC=0+-100	24546	C4-1/8-T0-101-F
A14R3	1810-0374	1	1	NETWORK-RES 8-SIP1.0K OHM X 4	01121	208R102
A14R4	0757-0442	9	2	RESISTOR 10K 1% .125W F TC=0+-100	24546	C4-1/8-T0-1002-F
A14R5	0757-0442	9	1	RESISTOR 10K 1% .125W F TC=0+-100	24546	C4-1/8-T0-1002-F
A14R6	0757-0199	3	1	RESISTOR 21.5K 1% .125W F TC=0+-100	24546	C4-1/8-T0-2152-F
A14U1	1820-0493	6	1	IC OP AMP GP 8-DIP-P PKG	27014	LM307N
A14U2	1826-0544	8	1	V REF 8-DIP-C	04713	MC1403U
A14Y1	0960-0636	4	1	OSCILLATOR, OVEN	28480	0960-0636
	1400-0957	7	2	BRACKET-RECTANGULAR	28480	1400-0957

See introduction to this section for ordering information
*Indicates factory selected value

Table 6-7. 5315B Option 004 Replaceable Parts

Reference Designation	HP Part Number	C D	Qty	Description	Mfr Code	Mfr Part Number
A15	05315-60112	7	1	REFERENCE OSCILLATOR ASSEMBLY; OVEN 5315B—OPTION 004	28480	05315-60112
A15C1	0160-4556	9	1	CAPACITOR-FXD 1000PF +-20% 100VDC CER	16299	CA302X7R102M100A
A15E1	9170-0029	3	2	CORE-SHIELDING BEAD	28480	9170-0029
A15E2	9170-0029	3		CORE-SHIELDING BEAD	28480	9170-0029
A15W1	05316-60103	7	1	CABLE ASSEMBLY—OSCILLATOR	28480	05316-60103
A15Y1	0960-0603	5	1	OSCILLATOR—OVEN	28480	0960-0603
				A15 MISCELLANEOUS PARTS		
	2200-0101	0	3	SCREW-MACH 4-40 .188-IN-LG PAN-HD-POZI	00000	ORDER BY DESCRIPTION
	05315-00024	4	1	BRACKET—OVEN	28480	05315-00024
A15A1	05315-60018	2	1	OVEN OSCILLATOR INTERCONNECT BOARD (SERIES 2120)	28480	05315-60018
A15A1C1	0160-4554	7	1	CAPACITOR-FXD .01UF +-20% 50VDC CER	28480	0160-4554
A15A1P1	1251-4510	9	1	CONNECTOR	28480	1251-4510
A15A1R1	0757-0401	0	1	RESISTOR 100 1% .125W F TC=0+-100	24546	04-1/8-T0-101-F
				A15A1 MISCELLANEOUS PARTS		
	1400-0957	7	2	BRACKET-RTANG .425-LG X .183-LG .25-WD	28480	1400-0957
	2360-0113	2	2	SCREW-MACH 6-32 .25-IN-LG PAN-HD-POZI	00000	ORDER BY DESCRIPTION

See introduction to this section for ordering information
*Indicates factory selected value

Table 6-8. Manufacturers Code List

MFR NO.	MANUFACTURER NAME	ADDRESS	ZIP CODE
00000	ANY SATISFACTORY SUPPLIER		
00853	SANGAMO ELEC CO S CAROLINA DIV	PICKENS SC	29671
01121	ALLEN-BRADLEY CO	MILWAUKEE WI	53204
01295	TEXAS INSTR INC SEMICONDCMPNT DIV	DALLAS TX	75222
0139E	GATES ENERGY PRODUCTS INC	DENVER CO	80217
0192B	RCA CORP SOLID STATE DIV	SOMERVILLE NJ	08876
02114	FERROXCUBE CORP	SAUGERTIES NY	12477
03508	GE CO SEMICONDUCTOR PROD DEPT	SYRACUSE NY	13201
03888	KDI PYROFILM CORP	WHIPPANY NJ	07981
04713	MOTOROLA SEMICONDUCTOR PRODUCTS	PHOENIX AZ	85062
05820	WAKEFIELD ENGINEERING INC	WAKEFIELD MA	01880
16299	CORNING GL WK ELEC CMPNT DIV	RALEIGH NC	27604
19701	MEPCO/ELECTRA CORP	MINERAL WELLS TX	76067
24546	CORNING GLASS WORKS (BRADFORD)	BRADFORD PA	16701
25088	SIEMENS CORP	ISELIN NJ	08830
27014	NATIONAL SEMICONDUCTOR CORP	SANTA CLARA CA	95051
28480	HEWLETT-PACKARD CO CORPORATE HQ	PALO ALTO CA	94304
32293	INTERSIL INC	CUPERTINO CA	95014
34335	ADVANCED MICRO DEVICES INC	SUNNYVALE CA	94086
50522	MONSANTO CO ELEK SPECIAL PROD	CUPERTINO CA	94304
51642	CENTRE ENGINEERING INC	STATE COLLEGE PA	16801
52763	STETTNER-TRUSH INC	CAZENOVIA NY	13035
56289	SPRAGUE ELECTRIC CO	NORTH ADAMS MA	01247
72136	ELECTRO MOTIVE CORP SUB IEC	WILLIMANTIC CT	06226
73138	BECKMAN INSTRUMENTS INC HELIPOT DIV	FULLERTON CA	92634
75915	LITTELFUSE INC	DES PLAINES IL	60016
91637	DALE ELECTRONICS INC	COLUMBUS NE	68601

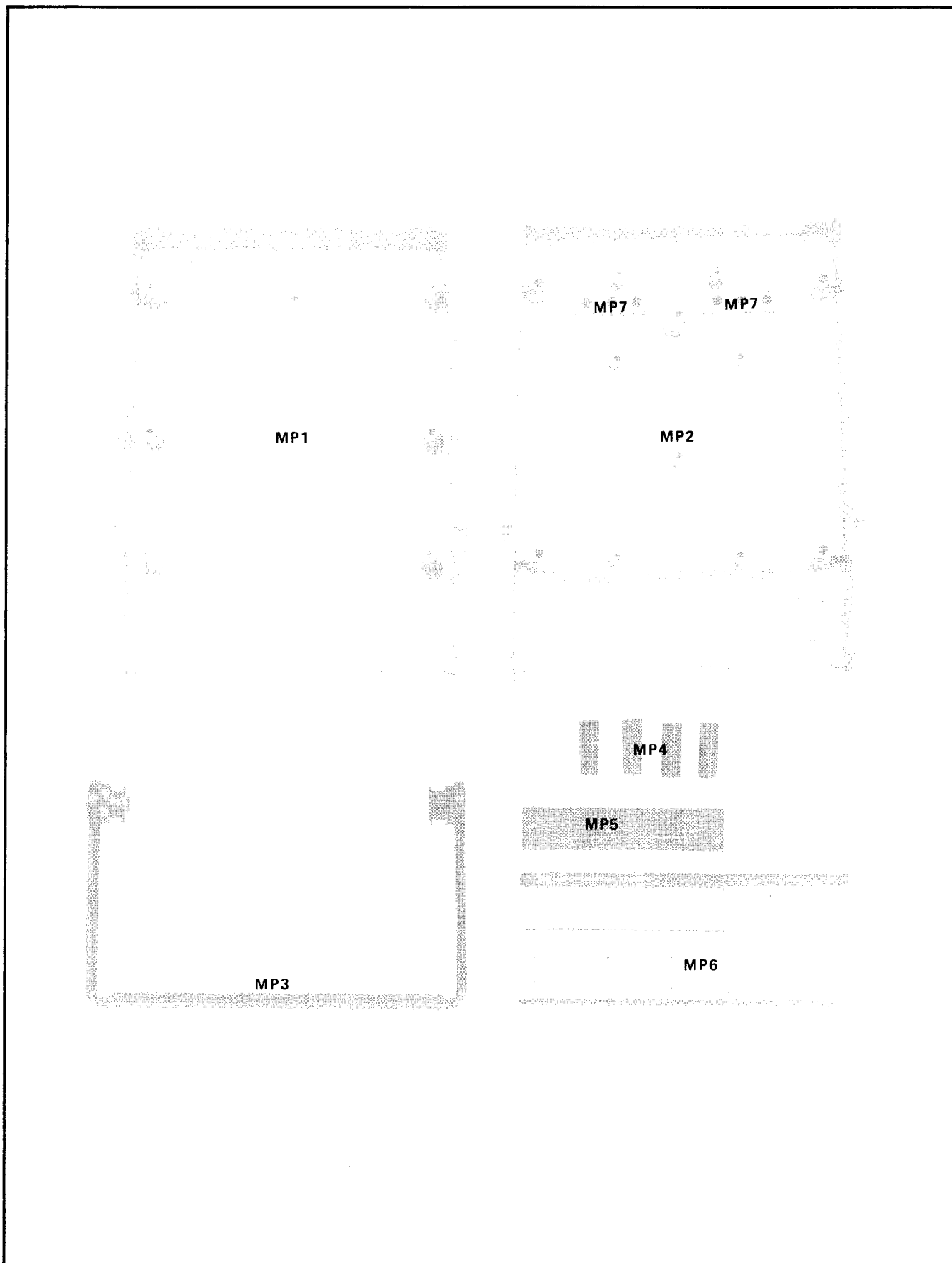

Figure 6-1. Model 5315A Mechanical Parts Layout

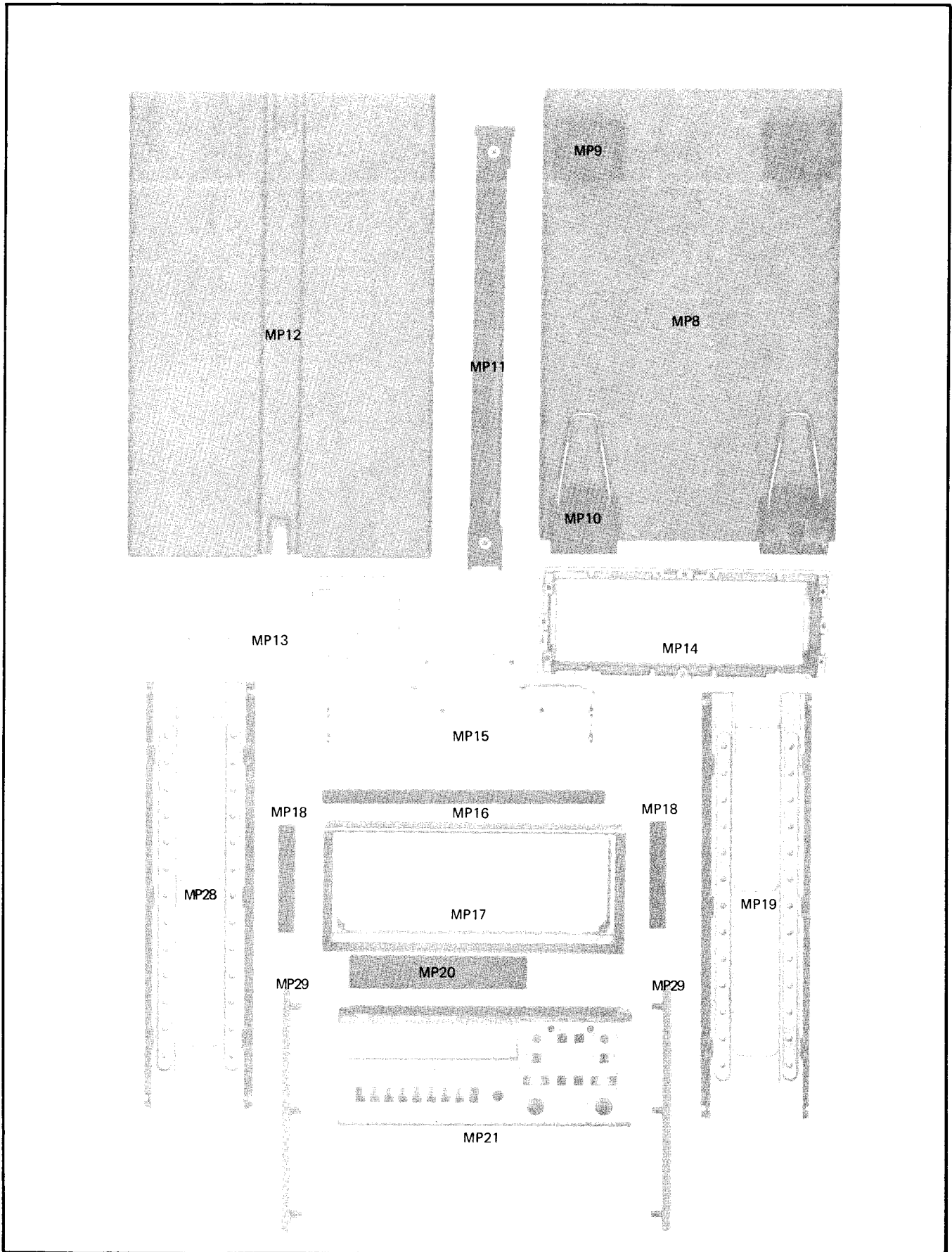

Figure 6-2. Model 5315B Mechanical Parts Layout

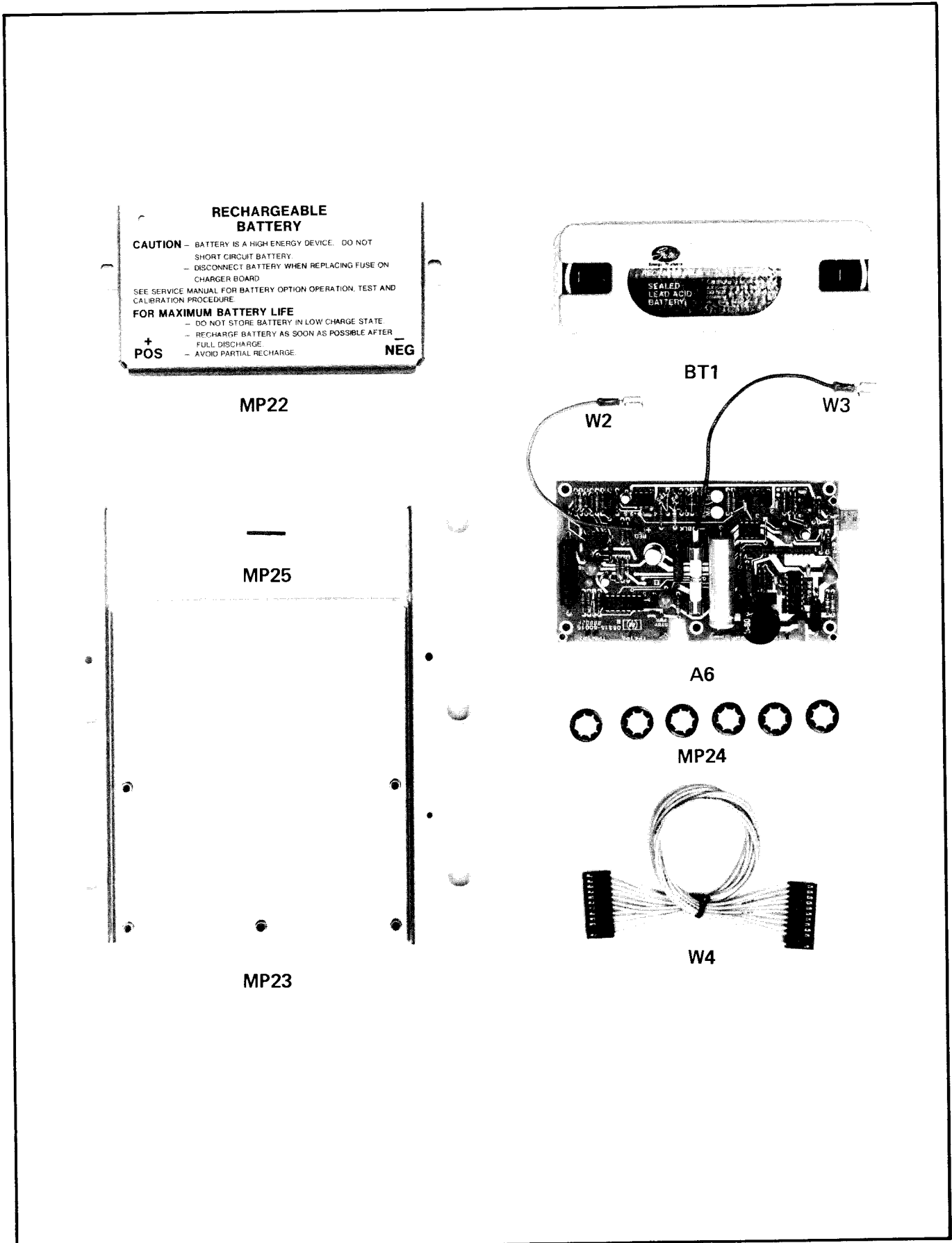
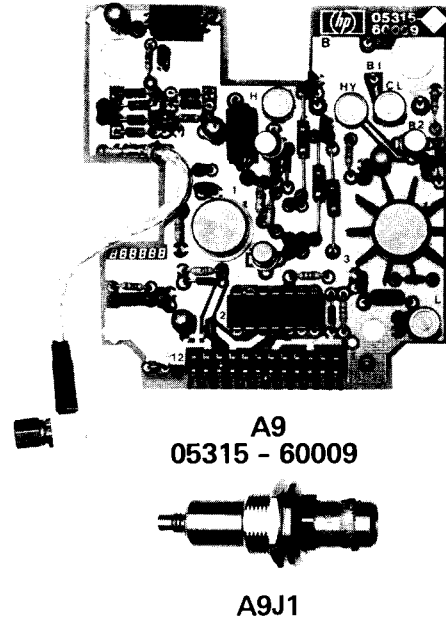
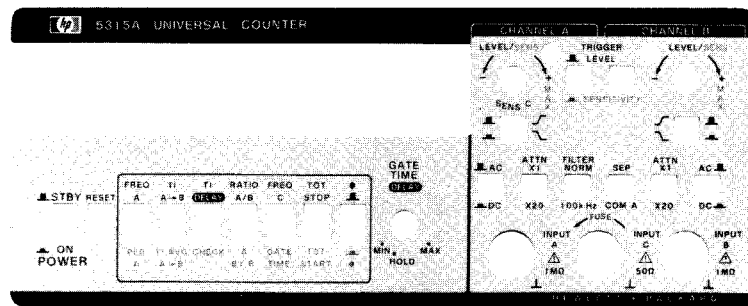

Figure 6-3. Option 002 Rechargeable Battery



W2
05315 - 60106
(NOT REQUIRED FOR
INSTRUMENTS WITH
SERIAL PREFIX
1928A OR HIGHER)



MP26

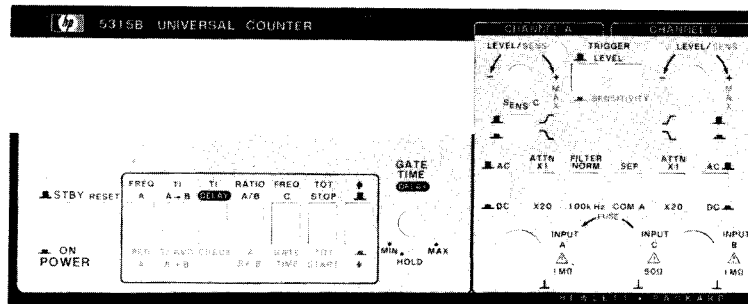

MP27

Figure 6-4. Option 003

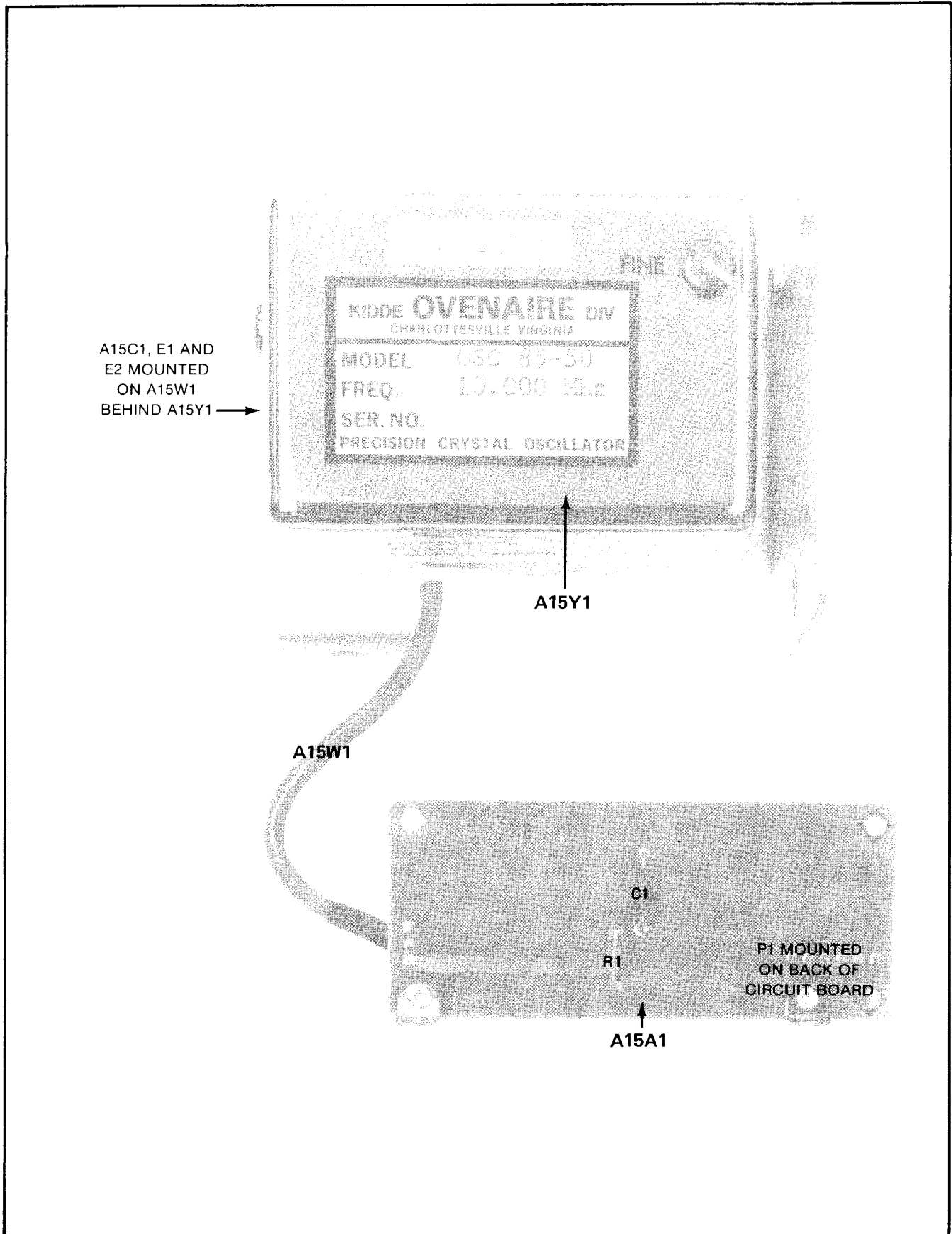

Figure 6-5. Option 004

SECTION VII MANUAL CHANGES

7-1. INTRODUCTION

7-2. This section contains information necessary to adapt this manual to older instruments.

7-3. MANUAL CHANGES

7-4. To adapt this manual to your instrument, refer to the serial number tag on the instrument rear panel and *Table 7-1*. Make the manual changes as determined by the series number found under each assembly designation and opposite the serial number prefix.

7-5. For parts lists and schematics to be changed, refer to the appropriate tables and figures in Sections VI and VIII unless otherwise noted.

7-6. Be sure to use the appropriate notes as indicated in *Table 7-1*. They may effect your manual change.

7-7. If your instrument serial number prefix is not listed on the title page of this manual or in *Table 7-1* below, it may be documented in a yellow MANUAL CHANGES supplement. Manuals for these instruments are supplied with a manual change sheet containing the required information. Contact the nearest Hewlett-Packard Office if this supplement is missing.

Table 7-1. Manual Changes by Series Number

Serial Number Prefix	Assembly Designation														
	A11.2.4	A1-"A"3.5	A1-"B"3.5	A2	A3	A4 ¹	A5	A6 ²	A6 ³	A7	A8	A9	A13 ³	A14 ³	A15 ³
1812A	1812	----	----	1812	1812	1812	----	1812	----	1812	----	----	----	----	----
1824A	1824	----	----	1824	1824	1824	----	1812	----	1824	----	----	----	----	----
1832A	1832	----	----	1824	1832	1824	----	1812	----	1824	----	----	----	----	----
1908A	1920	----	----	1824	1832	1824	----	1908	----	1824	----	----	----	----	----
1920A	1920	----	----	1824	1832	1824	----	1908	----	1824	----	----	----	----	----
1928A	1928	----	----	1824	1832	1824	----	1908	----	1824	----	1928	----	----	----
1948A	1928	----	----	1948	1832	1824	----	1908	----	1824	----	1928	----	----	----
2024A	1928	----	----	1948	2024	1824	----	1908	----	1824	----	1928	----	----	----
2032A	1928	----	----	1924	2024	1824	----	2032	----	1824	----	1928	----	----	----
2120A	----	2120	2120	1924	2024	1824	----	----	2120	1824	----	1928	2120	2120	2120

1. A1 and A4 Assembly series numbers both must be 1812 or both must be greater than 1812 to be compatible.
2. The A1 and A6 assemblies are compatible with each other only when the series numbers are 1812 through 2032.
3. The assemblies indicated (A1-"A" or A1-"B", A6, and A13, A14 or A15) are compatible with each other only when the series numbers are 2120 and above.
4. Instruments with serial number prefixes 1812A through 1920A require the A1 Assembly jumper as shown in the A9 Assembly Schematic in Section VIII.
5. A1-"A" is A1 Assembly of Model 5315A; A1-"B" is A1 Assembly of Model 5315B.

A1 ASSEMBLY

Series 1812

For A1 Assembly parts lists and schematics, use *Tables 7-3 and 7-4*, and *Figure 7-4*.
A1 adjustment locations are shown in *Figure 7-1*.

NOTE

For A1U2, 1820-2312 is the recommended replacement. A1R29 and A1R30, however, must be installed if 1820-2312 is used. Refer to A1 Assembly information under Series 1920.

Series 1824

Include A1 Assembly information from Series 1812 and as follows:
A1C14 is a 0.2-1.5 pF variable capacitor connected across A1C9.
A1R5 and A1R6 are 178 ohms. A1R5 is connected from +3V to A1U2-pin 28; A1R6 is connected from +3V to A1U2-pin 30.

Series 1832

Include A1 Assembly information from Series 1812, 1824 and as follows:
A1C7 is not used (5315A only).
A1C30 and A1C31 are 0.1 μ F. A1C30 is connected from the upper ac input (A1CR7) to ground.
A1C31 is connected from the lower ac input of A1CR7 to ground.
A1R27 is 1000 ohms. It is connected from the junction of A1CR6 and A1CR7 to ground.

Series 1920

Include A1 Assembly information from Series 1812, 1824, 1832 and as follows:
A1R29 is 23.7 ohms. It is connected from +3V to A1U2-pin 39.
A1R30 is 196 ohms. It is connected from A1U2-pin 39 to ground.
A1U2 is 1820-2312, CD1.

Series 1928

Include A1 Assembly information from Series 1812, 1824, 1832, 1920 and as follows:
A1C33 is 0.01 μ F. It is connected to A1U2-pin 39.
A1Q5 is not used.
A1R20 is not used. There is a direct connection from A1C26 to Q3-emitter.
A1R28 is 1000 ohms. It is connected from A1U3-pin 8 to ground.
A1U3B is connected in parallel with A1U3A, that is, pin 6 to pin 2, pin 5 to pin 3, and pin 7 to pin 1.
Show a connection from A1U1-pin 18 to J6-pin 1.
Show no connections from J6-pin 1 and J6-pin 11 to ground.
A1S1 is as shown in *Figure 7-2*. (This change is referenced to instrument serial number prefix 1948A rather than series number 1928).

Series 2120

Refer to other sections of this manual.

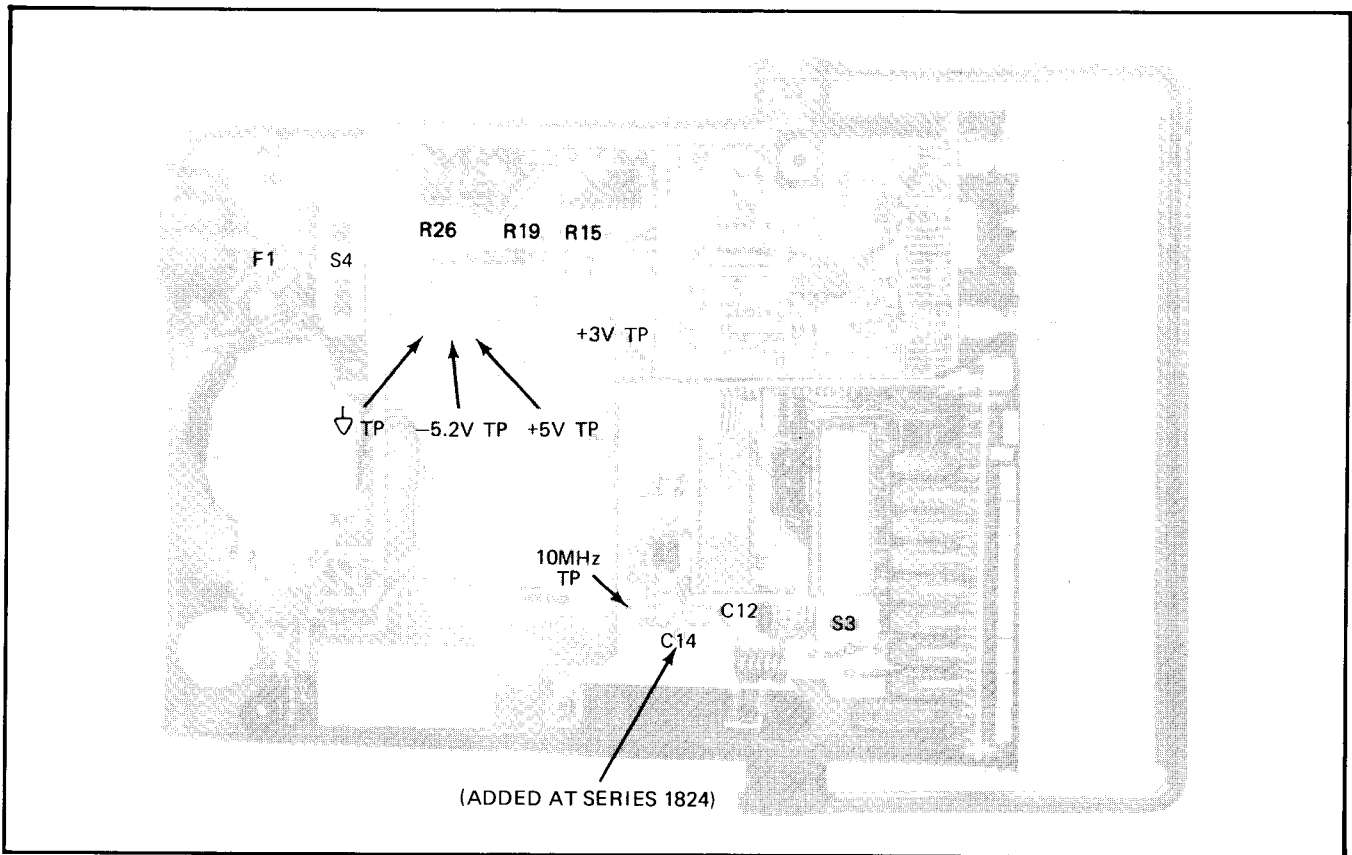

Figure 7-1. Adjustment Component Locator (A1 Assembly)
(A1 Assembly Series 1812 through 1928)

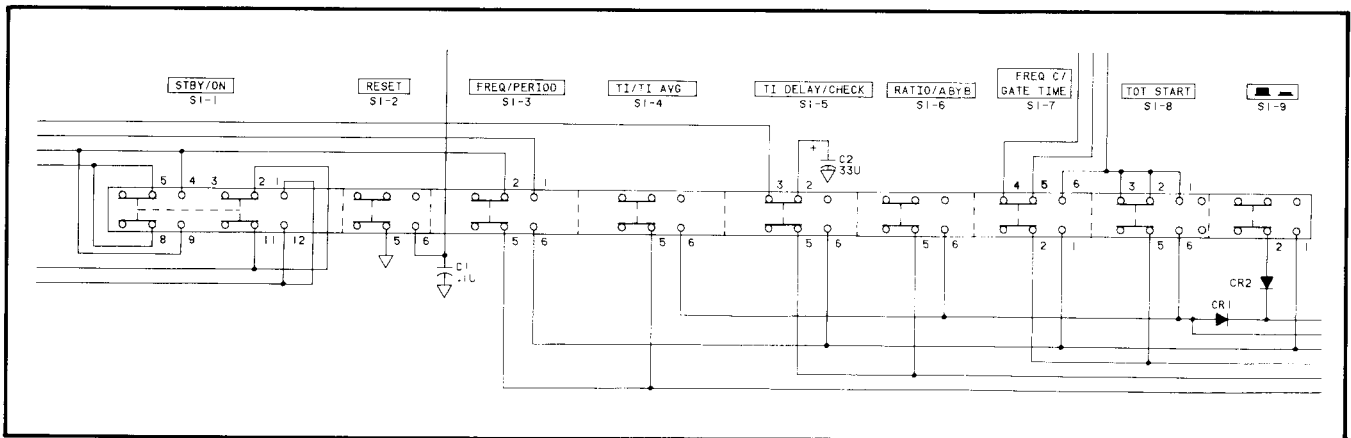

Figure 7-2. A1S1 Switch Assembly (A1 Assembly Series 1928)

A2 ASSEMBLY

Series 1812

For the A2 Assembly, use Table 6-2 and Figure 7-4 except:

- A2 Assembly is 05315-60002
- A2C1 is 68 pF
- A2XU3 is 1200-0555, CD5
- A2DS0 through A2DS8 are 1990-0658
- A2DS9 is 1990-0668
- A2DS10 through A2DS16 are 1990-0534

Series 1824

For the A2 Assembly, use *Table 6-2* and *Figure 7-4* except:

- A2 Assembly is 05315-60002
- A2C1 is 68 pF
- A2XU3 is 1200-0555, CD5
- A2DS0 through A2DS8 are 1990-0658
- A2DS9 is 1990-0668
- A2DS10 through A2DS16 are 1990-0534

Series 1924

Refer to other sections of this manual.

Series 1948

For A2 Assembly parts list and schematic, use *Table 6-2* and *Figure 7-4* except:

- A2 is 05315-60002
- A2DS0 through A2DS8 are 1990-0658
- A2DS9 is 1990-0668
- A2DS10 through A2DS16 are 1990-0534

A3 ASSEMBLY

Series 1812

A3C3 and A3C11 are 100 μ F

Series 1824

A3C3 and A3C11 are 100 μ F

Series 1832

A3C3 and A3C11 are 33 μ F
A3C8 is 68 pF connected to ground; A3R18 is not used

Series 2024

Refer to other sections of this manual.

A4 ASSEMBLY

Series 1812

A4R6 and A4R19 are 90.0 ohm
A4R9 and A4R13 are not used

Series 1824

Refer to other sections of this manual

A6 ASSEMBLY

Series 1812

For the A6 Assembly, use *Tables 7-2* and *7-5* and *Figures 7-3* and *7-5*.

Series 1908

For the A6 Assembly, use *Tables 7-2* and *7-5* and *Figures 7-3* and *7-5* except:

- A6CR7 is 1901-0782, DIODE-SCHOTTKY 1N5821 30V 3A.
- A6F1 is 2110-0447, 3A 125V FAST BLO .281 \times .093.

Series 2032

For the A6 Assembly, use *Tables 7-2* and *7-5* and *Figures 7-3* and *7-5* except:

- A6CR7 is 1901-0782, 1N5821, SCHOTTKY DIODE 30V 3A.
- A6F1 is 2110-0546, 5A FUSE.

Series 2120

Refer to other sections of this manual.

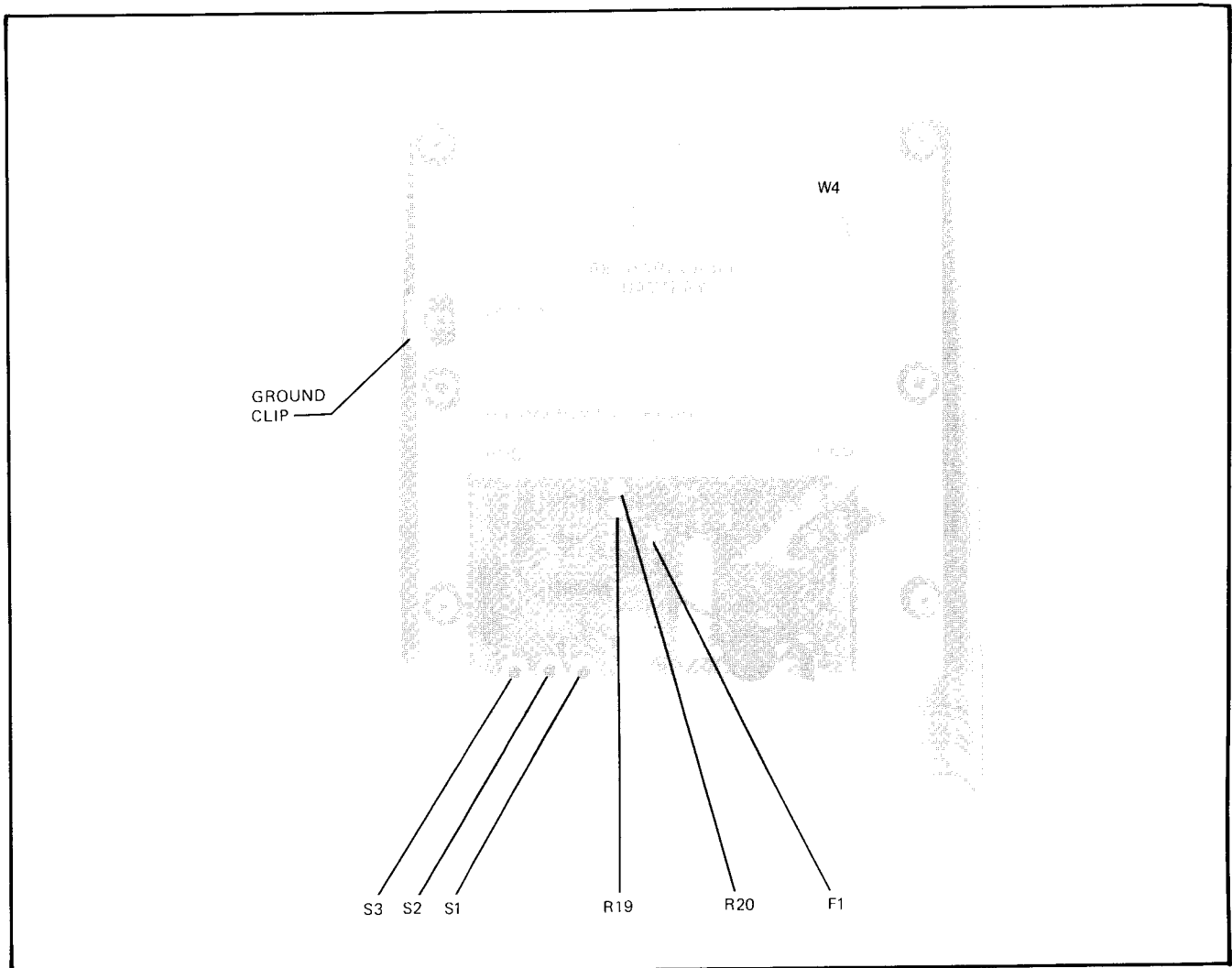

Figure 7-3. Option 002 Battery Charger Adjustment Locations
(A6 Assembly Series 1812 through 2032)

Table 7-2. A6 Adjustments (Series 1812 through 2032)

- a. Refer to *Figure 7-3*.
- b. Disconnect battery power cable from 5315A.
- c. Disconnect battery from A6 (05315-60006) battery charger assembly board.
- d. Connect cable W4 between A1J4 and A6J1.
- e. Connect DVM positive lead to A6W2 (red wire) and negative lead to a ground on battery charger assembly board (e.g., TP3).
- f. Connect power cable to 5315A; set STBY/ON switch to STBY position.
- g. Adjust A6R20 fully counterclockwise.
- h. Hold switch S3 down while adjusting A6R19 until DVM reads 7.71 volts; adjust A6R20 until charging LED (CHGD) turns on. Release switch S3.
- i. Connect DVM negative lead to A6W3 (black wire); short TP3 to TP7. Hold switch S3 down while adjusting A6R19 until DVM reads 6.00V.
- j. Set STBY/ON switch to the ON position. Hold switch S2 down; DVM should read $2.0 \pm 0.4/-0.1$ volts. Remove all shorts and turn instrument off.
- k. Disconnect all test equipment.

A7 ASSEMBLY

Series 1812

Refer to other sections of this manual.

Series 1824

Refer to other sections of this manual.

A9 ASSEMBLY

Series 1928

Refer to other sections of this manual.

A13, A14 AND A15 ASSEMBLIES

Series 2120

Refer to other sections of this manual.

Table 7-3. 5315A-A1 Assembly Replaceable Parts

Reference Designation	HP Part Number	C D	Qty	Description	Mfr Code	Mfr Part Number
A1	05315-60001	3	1	MOTHERBOARD ASSEMBLY (FOR 5315A ONLY) (SERIES 1912)	28480	05315-60001
A1C1	0160-4557	0	2	CAPACITOR-FXD .10UF +-20% 50VDC CER	16299	CAC04X7R104M050A
A1C2	0180-0562	1	3	CAPACITOR-FXD 330F+-20% 10VDC TA	56289	196D336X0010KA1
A1C3	0180-2698	8	1	CAPACITOR-FXD 4.7UF+-10% 35VDC TA	28480	0180-2698
A1C4	0180-0562	1	1	CAPACITOR-FXD 330F+-20% 10VDC TA	56289	196D336X0010KA1
A1C5	0160-4554	7	5	CAPACITOR-FXD .010UF +-20% 50VDC CER	28480	0160-4554
A1C6	0160-4554	7	1	CAPACITOR-FXD .010UF +-20% 50VDC CER	28480	0160-4554
A1C7	0160-3333	8	1	CAPACITOR-FXD 5000PF +-20% 250VAC(RMS)	28480	0160-3333
A1C8	0160-4554	7	1	CAPACITOR-FXD .010UF +-20% 50VDC CER	28480	0160-4554
A1C9	0160-2150	5	1	CAPACITOR-FXD 33PF +-5% 300VDC MICA	28480	0160-2150
A1C10	0160-3879	7	4	CAPACITOR-FXD .010UF +-20% 100VDC CER	28480	0160-3879
A1C11	0160-3879	7	1	CAPACITOR-FXD .010UF +-20% 100VDC CER	28480	0160-3879
A1C12	0121-0861	1	1	CAPACITOR-V TRMR CER 5.0-18PF 350V	52763	344322 5.0/18PF NPO
A1C13	0160-3879	7	1	CAPACITOR-FXD .010UF +-20% 100VDC CER	28480	0160-3879
A1C14				NOT ASSIGNED		
A1C15	0160-2204	0	1	CAPACITOR-FXD 100PF +-5% 300VDC MICA	28480	0160-2204
A1C16	0140-0210	2	1	CAPACITOR-FXD 220PF +-5% 300VDC MICA	72136	DM15F271J0300WV1CR
A1C17	0180-0562	1	1	CAPACITOR-FXD 330UF+-20% 10VDC TA	56289	196D336X0010KA1
A1C18	0160-4554	7	1	CAPACITOR-FXD .010UF +-20% 50VDC CER	28480	0160-4554
A1C19	0160-4557	0	1	CAPACITOR-FXD .10UF +-20% 50VDC CER	16299	CAC04X7R104M050A
A1C20	0160-4554	7	1	CAPACITOR-FXD .010UF +-20% 50VDC CER	28480	0160-4554
A1C21	0180-2820	8	2	CAPACITOR-FXD .220UF+-20% 35VDC TA	28480	0180-2820
A1C22	0160-3879	7	1	CAPACITOR-FXD .010UF +-20% 100VDC CER	28480	0160-3879
A1C23	0180-2816	2	2	CAPACITOR-FXD 680UF+-20% 10VDC TA	28480	0180-2816
A1C24	0180-2815	1	1	CAPACITOR-FXD 100UF+-20% 10VDC TA	28480	0180-2815
A1C25	0140-0193	0	1	CAPACITOR-FXD 82PF +-5% 300VDC MICA	72136	DM15F820J0300WV1CR
A1C26	0180-1735	2	1	CAPACITOR-FXD .220UF+-10% 35VDC TA	56289	150D224X9035A2
A1C27	0180-2891	3	1	CAPACITOR-FXD 4700UF+100-10% 15VDC AL	28480	0180-2891
A1C28	0180-2816	2	1	CAPACITOR-FXD 680UF+-20% 10VDC TA	28480	0180-2816
A1C29	0180-2820	8	1	CAPACITOR-FXD .220UF+-20% 35VDC TA	28480	0180-2820
A1C30				NOT ASSIGNED		
A1C31				NOT ASSIGNED		
A1C32	0180-2892	4	1	CAPACITOR-FXD 2200UF+75-10% 16VDC AL	28480	0180-2892
A1C33				NOT ASSIGNED		
A1CR1	1901-0040	1	5	DIODE-SWITCHING 30V 50MA 2NS DO-35	28480	1901-0040
A1CR2	1901-0040	1	1	DIODE-SWITCHING 30V 50MA 2NS DO-35	28480	1901-0040
A1CR3	1901-0040	1	1	DIODE-SWITCHING 30V 50MA 2NS DO-35	28480	1901-0040
A1CR4	1901-0040	1	1	DIODE-SWITCHING 30V 50MA 2NS DO-35	28480	1901-0040
A1CR5	1901-0040	1	1	DIODE-SWITCHING 30V 50MA 2NS DO-35	28480	1901-0040
A1CR6	1901-0473	6	1	DIODE-PWR RECT 100V 5A SUS	03508	A15A
A1CR7	1906-0896	7	1	DIODE-FW BRDG 200V 2A	04713	MDA202
A1F1	2110-0201	0	1	FUSE .25A 250V TD 1.25X.25 UL	75915	313.250
A1J1	1251-4743	0	1	CONNECTOR-AC PWR HP-9 MALE REC-FLG THRM	28480	1251-4743
A1J2	1251-4215	1	1	CONNECTOR 6-PIN F POST TYPE	28480	1251-4215
A1J3				NOT ASSIGNED		
A1J4	1251-5370	1	2	CONNECTOR 11-PIN M POST TYPE	28480	1251-5370
A1J5	1251-5281	3	1	CONNECTOR 12-PIN F POST TYPE	28480	1251-5281
A1J6	1251-5370	1	1	CONNECTOR 11-PIN M POST TYPE	28480	1251-5370
A1J7	1200-0423	8	1	SOCKET-IC 16-CONT DIP DIP-SLDR	28480	1200-0423
A1L1	9140-0237	2	1	INDUCTOR RF-CH-MLD 200UH 5% .166DX.385LG	28480	9140-0237
A1Q1	1854-0477	7	3	TRANSISTOR NPN 2N2222A SI TO-18 PD=500MW	04713	2N2222A
A1Q2	1854-0477	7	1	TRANSISTOR NPN 2N2222A SI TO-18 PD=500MW	04713	2N2222A
A1Q3	1853-0363	3	1	TRANSISTOR PNP SI PD=50W FT=20MHZ	03508	X45H281
A1Q4	1854-0477	7	1	TRANSISTOR NPN 2N2222A SI TO-18 PD=500MW	04713	2N2222A
A1Q5	1853-0036	2	1	TRANSISTOR PNP SI PD=310MW FT=250MHZ	28480	1853-0036
A1R1	2100-3719	0	1	RESISTOR-VARIABLE W/SW 470K OHM +-20%	28480	2100-3719
A1R2	0698-0884	9	2	RESISTOR 2.15K 1% .125W F TC=0+-100	24546	C4-1/8-10-2151-F
A1R3	0698-0882	7	1	RESISTOR 464 1% .125W F TC=0+-100	24546	C4-1/8-10-4640-F
A1R4				NOT ASSIGNED		
A1R5				NOT ASSIGNED		
A1R6				NOT ASSIGNED		
A1R7	0757-0199	3	4	RESISTOR 21.5K 1% .125W F TC=0+-100	24546	C4-1/8-T0-2152-F
A1R8	0757-0199	3	3	RESISTOR 21.5K 1% .125W F TC=0+-100	24546	C4-1/8-T0-2152-F
A1R9	0757-0280	3	3	RESISTOR 1K 1% .125W F TC=0+-100	24546	C4-1/8-T0-1001-F
A1R10	0757-0280	3	3	RESISTOR 1K 1% .125W F TC=0+-100	24546	C4-1/8-T0-1001-F
A1R11	0757-0280	3	1	RESISTOR 1K 1% .125W F TC=0+-100	24546	C4-1/8-T0-1001-F
A1R12	0698-3443	8	2	RESISTOR 287 1% .125W F TC=0+-100	24546	C4-1/8-T0-287R-F
A1R13	0698-3442	9	2	RESISTOR 237 1% .125W F TC=0+-100	24546	C4-1/8-T0-237R-F
A1R14	0698-3443	8	1	RESISTOR 287 1% .125W F TC=0+-100	24546	C4-1/8-T0-287R-F
A1R15	2100-0568	1	2	RESISTOR-TRMR 100 10% C TOP-ADJ 1-TRN	28480	2100-0568

See introduction to this section for ordering information
*Indicates factory selected value

Table 7-3. 5315A-A1 Assembly Replaceable Parts (Continued)

Reference Designation	HP Part Number	C D	Qty	Description	Mfr Code	Mfr Part Number
A1R16	0757-0199	3		RESISTOR 21.5K 1% .125W F TC=0+-100	24546	C4-178-T0-2152-F
A1R17	0698-3434	9	1	RESISTOR 34.8 1% .125W F TC=0+-100	24546	C4-178-T0-3482-F
A1R18	0698-3157	3	1	RESISTOR 19.6K 1% .125W F TC=0+-100	24546	C4-178-T0-1962-F
A1R19	2100-3252	6	1	RESISTOR-TRMR 5k 10% C TOP-ADJ 1-TRN	28480	2100-3252
A1R21	0698-0084	9		RESISTOR 2.15K 1% .125W F TC=0+-100	24546	C4-178-T0-2151-F
A1R22	0757-0199	3		RESISTOR 21.5K 1% .125W F TC=0+-100	24546	C4-178-T0-2152-F
A1R23	0698-3442	9		RESISTOR 237 1% .125W F TC=0+-100	24546	C4-178-T0-2372-F
A1R24	0757-0403	2	1	RESISTOR 121 1% .125W F TC=0+-100	24546	C4-178-T0-1212-F
A1R25	0698-3444	1	1	RESISTOR 316 1% .125W F TC=0+-100	24546	C4-178-T0-3162-F
A1R26	2100-0568	1		RESISTOR-TRMR 100 10% C TOP-ADJ 1-TRN	28480	2100-0568
A1R27				NOT ASSIGNED		
A1R28				NOT ASSIGNED		
A1R29				NOT ASSIGNED		
A1R30				NOT ASSIGNED		
A1S1	3101-2297	0	1	SWITCH-PB 9-STATION 10MM C-C SPACING PART OF A1R1	28480	3101-2297
A1S2	3101-2334	6	1	SWITCH-SL DPDT SUBMIN .5A 125VAC/DC PC	28480	3101-2334
A1S3	3101-0693	6	1	SWITCH-SL 2-DPDT STD 1.5A 250VAC PC	28480	3101-0693
A1S4						
A1U1	1820-2131	3	1	IC	04713	MC3870P
A1U2	1820-2139	1	1	IC	28480	1820-2139
A1U3	1826-0424	5	1	IC OP AMP GP DUAL 14-DIP-P PKG	04713	MC3405P
A1U4	1826-0393	7	1	IC V RGLTR T0-220	27014	LM317T
A1U5	1826-0544	0	1	V REF B-DIP-C	04713	MC1403U
A1U6	1826-0527	9	1	IC 337 V RGLTR T0-220	27014	LM337T
A1XU1	1200-0552	4	2	SOCKET-IC 40-CONT DIP-SLDR	28480	1200-0552
A1XU2	1200-0552	4		SOCKET-IC 40-CONT DIP-SLDR	28480	1200-0552
A1Y1	0410-0423	2	1	CRYSTAL-QUARTZ 10.000 MHZ	28480	0410-0423
				A1 MISCELLANEOUS PARTS		
	0340-0864	6	3	INSULATOR-XSTR THRM-CONDCT	28480	0340-0864
	0380-0745	6	4	STANDOFF-RVT-DN .187-IN-LG 6-32THD	00000	ORDER BY DESCRIPTION
	0380-0770	7	4	STANDOFF-RVT-DN .1875-IN-LG 6-32THD	00000	ORDER BY DESCRIPTION
	2110-0269	0	2	FUSEHOLDER-CLIP TYPE .250-FUSE	28480	2110-0269
	05315-00001	7	1	HEAT SINK	28480	05315-00001

See introduction to this section for ordering information
*Indicates factory selected value

Table 7-4. 5315B-A1 Assembly Replaceable Parts

Reference Designation	HP Part Number	C D	Qty	Description	Mfr Code	Mfr Part Number
A1	05315-60000	0	1	MOTHERBOARD ASSEMBLY (FOR 5315B ONLY) (SERIES 1812)	28480	05315-60000
A1C1	0160-4557	0	2	CAPACITOR-FXD .10UF +-20% 50VDC CER	16299	CAC04X7R104M050A
A1C2	0180-0562	1	3	CAPACITOR-FXD 33UF+-20% 10VDC TA	56289	196D336X0010KA1
A1C3	0180-2698	8	1	CAPACITOR-FXD 4.7UF+-10% 35VDC TA	28480	0180-2698
A1C4	0180-0562	1	1	CAPACITOR-FXD 33UF+-20% 10VDC TA	56289	196D336X0010KA1
A1C5	0160-4554	7	5	CAPACITOR-FXD .01UF +-20% 50VDC CER	28480	0160-4554
A1C6	0160-4554	7	1	CAPACITOR-FXD .01UF +-20% 50VDC CER	28480	0160-4554
A1C7				NOT ASSIGNED		
A1C8	0160-4554	7	1	CAPACITOR-FXD .01UF +-20% 50VDC CER	28480	0160-4554
A1C9*	0160-2150	5	1	CAPACITOR-FXD 33PF +-5% 300VDC MICA	28480	0160-2150
A1C10	0160-3879	7	4	CAPACITOR-FXD .01UF +-20% 100VDC CER	28480	0160-3879
A1C11	0160-3879	7	1	CAPACITOR-FXD .01UF +-20% 100VDC CER	28480	0160-3879
A1C12	0121-0061	1	1	CAPACITOR-V TRMR-CER 5.5-18PF 350V	52763	30A322 5.5/18PF NPD
A1C13	0160-3879	7	1	CAPACITOR-FXD .01UF +-20% 100VDC CER	28480	0160-3879
A1C14				NOT ASSIGNED		
A1C15	0160-2204	0	1	CAPACITOR-FXD 100PF +-5% 300VDC MICA	28480	0160-2204
A1C16	0140-0210	2	1	CAPACITOR-FXD 270PF +-5% 300VDC MICA	72136	DM15F271J0300WV1CR
A1C17	0180-0562	1	1	CAPACITOR-FXD 33UF+-20% 10VDC TA	56289	196D336X0010KA1
A1C18	0160-4554	7	1	CAPACITOR-FXD .01UF +-20% 50VDC CER	28480	0160-4554
A1C19	0160-4557	7	1	CAPACITOR-FXD .10UF +-20% 50VDC CER	16299	CAC04X7R104M050A
A1C20	0160-4554	0	2	CAPACITOR-FXD .01UF +-20% 50VDC CER	28480	0160-4554
A1C21	0180-2820	8	2	CAPACITOR-FXD .22UF+-20% 35VDC TA	28480	0180-2820
A1C22	0160-3879	7	1	CAPACITOR-FXD .01UF +-20% 100VDC CER	28480	0160-3879
A1C23	0180-2816	2	2	CAPACITOR-FXD 68UF+-20% 10VDC TA	28480	0180-2816
A1C24	0180-2815	1	1	CAPACITOR-FXD 100UF+-20% 10VDC TA	28480	0180-2815
A1C25	0140-0193	0	1	CAPACITOR-FXD 82PF +-5% 300VDC MICA	72136	DM15E820J0300WV1CR
A1C26	0180-1735	2	1	CAPACITOR-FXD .22UF+-10% 35VDC TA	56289	150D224X9035A2
A1C27	0180-2891	3	1	CAPACITOR-FXD 4700UF+100-10% 15VDC AL	28480	0180-2891
A1C28	0180-2816	2	1	CAPACITOR-FXD 68UF+-20% 10VDC TA	28480	0180-2816
A1C29	0180-2820	8	1	CAPACITOR-FXD .22UF+-20% 35VDC TA	28480	0180-2820
A1C30				NOT ASSIGNED		
A1C31				NOT ASSIGNED		
A1C32	0180-2892	4	1	CAPACITOR-FXD 2200UF+75-10% 16VDC AL	28480	0180-2892
A1C33				NOT ASSIGNED		
A1CR1	1901-0040	1	5	DIODE-SWITCHING 30V 50MA 2NS DO-35	28480	1901-0040
A1CR2	1901-0040	1	1	DIODE-SWITCHING 30V 50MA 2NS DO-35	28480	1901-0040
A1CR3	1901-0040	1	1	DIODE-SWITCHING 30V 50MA 2NS DO-35	28480	1901-0040
A1CR4	1901-0040	1	1	DIODE-SWITCHING 30V 50MA 2NS DO-35	28480	1901-0040
A1CR5	1901-0040	1	1	DIODE-SWITCHING 30V 50MA 2NS DO-35	28480	1901-0040
A1CR6	1901-0673	6	1	DIODE-PWR RECT 100V 5A 5US	03508	A15A
A1CR7	1906-0096	7	1	DIODE-FW BRDG 200V 2A	04713	MDA202
A1J2	1251-4215	1	1	CONNECTOR 6-PIN F POST TYPE	28480	1251-4215
A1J3				NOT ASSIGNED		
A1J4	1251-5370	1	2	CONNECTOR 11-PIN M POST TYPE	28480	1251-5370
A1J5	1251-5281	3	1	CONNECTOR 12-PIN F POST TYPE	28480	1251-5281
A1J6	1251-5370	1	1	CONNECTOR 11-PIN M POST TYPE	28480	1251-5370
A1J7	1200-0423	8	1	SOCKET-IC 16-CONT DTP DIP-SLDR	28480	1200-0423
A1L1	9140-0237	2	1	INDUCTOR RF-CH-MLD 2000H 5% .166DX.385LC	28480	9140-0237
A1Q1	1854-0477	7	3	TRANSISTOR NPN 2N2222A SI T0-18 PD=500MW	04713	2N2222A
A1Q2	1854-0477	7	1	TRANSISTOR NPN 2N2222A SI T0-18 PD=500MW	04713	2N2222A
A1Q3	1853-0363	8	1	TRANSISTOR PNP SI PD=50W FT=20MHZ	03508	X45HC81
A1Q4	1854-0477	7	1	TRANSISTOR NPN 2N2222A SI T0-18 PD=500MW	04713	2N2222A
A1Q5	1853-0036	2	1	TRANSISTOR PNP SI PD=310MW FT=250MHZ	28480	1853-0036
A1R1	2100-3719	0	1	RESISTOR-VARIABLE W/SW 470K OHM +-20%	28480	2100-3719
A1R2	0698-0084	9	2	RESISTOR 2.15K 1% .125W F TC=0+-100	24546	C4-1/8-T0-2151-F
A1R3	0698-0082	7	1	RESISTOR 464 1% .125W F TC=0+-100	24546	C4-1/8-T0-4640-F
A1R4				NOT ASSIGNED		
A1R5				NOT ASSIGNED		
A1R6				NOT ASSIGNED		
A1R7	0757-0199	3	4	RESISTOR 21.5K 1% .125W F TC=0+-100	24546	C4-1/8-T0-2152-F
A1R8	0757-0199	3	1	RESISTOR 21.5K 1% .125W F TC=0+-100	24546	C4-1/8-T0-2152-F
A1R9	0757-0280	3	3	RESISTOR 1K 1% .125W F TC=0+-100	24546	C4-1/8-T0-1001-F
A1R10	0757-0280	3	1	RESISTOR 1K 1% .125W F TC=0+-100	24546	C4-1/8-T0-1001-F
A1R11	0757-0280	3	1	RESISTOR 1K 1% .125W F TC=0+-100	24546	C4-1/8-T0-1001-F
A1R12	0698-3443	0	2	RESISTOR 287 1% .125W F TC=0+-100	24546	C4-1/8-T0-287R-F
A1R13	0698-3442	9	2	RESISTOR 237 1% .125W F TC=0+-100	24546	C4-1/8-T0-237R-F
A1R14	0698-3443	0	1	RESISTOR 287 1% .125W F TC=0+-100	24546	C4-1/8-T0-287R-F
A1R15	2100-0568	1	2	RESISTOR-TRMP 100 10% C TOP-ADJ 1-TRN	28480	2100-0568

See introduction to this section for ordering information
*Indicates factory selected value

Table 7-4. 5315B-A1 Assembly Replaceable Parts (Continued)

Reference Designation	HP Part Number	C D	Qty	Description	Mfr Code	Mfr Part Number
A1R16	0757-0199	3		RESISTOR 21.5K 1% .125W F TC=0+-100		
A1R17	0698-3434	9	1	RESISTOR 34.8 1% .125W F TC=0+-100	24546	C4-1/8-T0-215C-F
A1R18	0698-3152	3	1	RESISTOR 19.6K 1% .125W F TC=0+-100	24546	C4-1/8-T0-348B-F
A1R19	2100-3252	6	1	RESISTOR-TRMR 5K 10% C TOP-ADJ 1-TPN	24546	C4-1/8-T0-196C-F
A1R20				NOT ASSIGNED	28480	2100-3252
A1R21	0698-0084	9		RESISTOR 2.15K 1% .125W F TC=0+-100		
A1R22	0757-0199	3		RESISTOR 21.5K 1% .125W F TC=0+-100	24546	C4-1/8-T0-215C-F
A1R23	0698-3442	9		RESISTOR 237 1% .125W F TC=0+-100	24546	C4-1/8-T0-215C-F
A1R24	0757-0403	2	1	RESISTOR 121 1% .125W F TC=0+-100	24546	C4-1/8-T0-237P-F
A1R25	0698-3444	1	1	RESISTOR 316 1% .125W F TC=0+-100	24546	C4-1/8-T0-121R-F
A1R26						
A1R27	2100-0568	1		RESISTOR-TRMR 100 10% C TOP-ADJ 1-TSP	28480	2100-0568
A1R28				NOT ASSIGNED		
A1R29				NOT ASSIGNED		
A1R30				NOT ASSIGNED		
A1S1	3101-2297	0	1	SWITCH-PR 9-STATION 18MM C C SPACING	28480	3101-2297
A1S2				PART OF A1R1		
A1S3	3101-2334	6	1	SWITCH-SL DPDT SUBMIN .15A 125VAC/DC PC	28480	3101-2334
A1S4	3101-0693	6	1	SWITCH-SL 2-DPDT STD 1.5A 250VAC PC	28480	3101-0693
A1U1	1826-2131	3	1	IC	04713	MC3070P
A1U2	1826-2139	1	1	IC	28480	1826-2139
A1U3	1826-0424	5	1	IC OP AMP GP DUAL 14-DIP-P PKG	04713	MC3405P
A1U4	1826-0393	7	1	IC V RGLTR TO-220	27014	LM317T
A1U5	1826-0544	0	1	V RCF 8-DIP-C	04713	MC1403D
A1U6	1826-0527	9	1	IC 337 V RGLTR TO-220	27014	LM337T
A1XU1	1200-0552	4	2	SOCKET-IC 40-CONT DIP-SLDR	28480	1200-0552
A1XU2	1200-0552	4		SOCKET-IC 40-CONT DIP-SLDR	28480	1200-0552
A1Y1	0410-0423	2	1	CRYSTAL-QUARTZ 10.000 MHZ	28480	0410-0423
				A1 MISCELLANEOUS PARTS		
	0340-0864	6	3	INSULATOR-XSTR THRM-CONDCT	28480	0340-0864
	0380-0745	6	4	STANDOFF-RVT-ON .187-IN-IC 6-32THD	00000	ORDER BY DESCRIPTION
	0380-0770	7	4	STANDOFF-RVT-ON .025-IN-IC 6-32THD	00000	ORDER BY DESCRIPTION
	2110-0269	0	3	FUSEHOLDER-CLIP TYPE .250-FUSE	28480	2110-0269
	05315-00001	7	1	HEAT SINK	28480	05315-00001
	3050-0791	6	3	INSULATOR-XSTR NYLON	28480	3050-0791

See introduction to this section for ordering information
*Indicates factory selected value

Table 7-5. 5315A-A6 Assembly Replaceable Parts

Reference Designation	HP Part Number	C D	Qty	Description	Mfr Code	Mfr Part Number
A6	05315-60006	8	1	BATTERY CHARGER ASSEMBLY 5315A ONLY; OPTION 002; SERIES 1812	28480	05315-60006
A6C1	0160-4557	0	2	CAPACITOR-FXD .1UF +-20% 50VDC CER	16299	CAC04X7R104M050A
A6C2	0180-2815	1	1	CAPACITOR-FXD 100UF+-20% 10VDC TA	28480	0180-2815
A6C3	0180-2821	9	2	CAPACITOR-FXD 22UF+-20% 35VDC TA	28480	0180-2821
A6C4	0160-0576	5	5	CAPACITOR-FXD .1UF +-20% 50VDC CER	28480	0160-0576
A6C5	0160-0134	1	1	CAPACITOR-FXD 220PF +-5% 300VDC MICA	28480	0160-0134
A6C6	0160-4557	0		CAPACITOR-FXD .1UF +-20% 50VDC CER	16299	CAC04X7R104M050A
A6C7	0160-0576	5		CAPACITOR-FXD .1UF +-20% 50VDC CER	28480	0160-0576
A6C8	0180-2686	4	1	CAPACITOR-FXD 470UF+100-10% 25VDC AI	00853	3B1AFR4710025R
A6C9	0160-0576	5		CAPACITOR-FXD .1UF +-20% 50VDC CER	28480	0160-0576
A6C10	0180-2821	9		CAPACITOR-FXD 22UF+-20% 35VDC TA	28480	0180-2821
A6C11	0180-0562	1	1	CAPACITOR-FXD 33UF+-20% 10VDC TA	56289	196D336X0010KA1
A6C12	0160-0576	5		CAPACITOR-FXD .1UF +-20% 50VDC CER	28480	0160-0576
A6C13	0160-0576	5		CAPACITOR-FXD .1UF +-20% 50VDC CER	28480	0160-0576
A6CR1	1901-0734	0	1	DIODE-PWR RECT 1N5818 30V 1A	04713	1N5818
A6CR2	1901-0050	3	3	DIODE-SWITCHING 80V 200MA 2NS DO-35	28480	1901-0050
A6CR3	1901-0050	3		DIODE-SWITCHING 80V 200MA 2NS DO-35	28480	1901-0050
A6CR4	1901-0050	3		DIODE-SWITCHING 80V 200MA 2NS DO-35	28480	1901-0050
A6CR5	1901-0691	8	1	DIODE-PWR RECT 100V 3A 200NS	03508	6115A
A6CR6	1901-0460	9	1	DIODE-STABISTOR 30V 150MA DO-7	28480	1901-0460
A6CR7	1901-0676	9	1	DIODE-SCHOTTKY 20V 5A	28480	1901-0676
A6CR8	1901-0050	3		DIODE-SWITCHING 80V 200MA 2NS DO-35	28480	1901-0050
A6CR9	1901-0050	3		DIODE-SWITCHING 80V 200MA 2NS DO-35	28480	1901-0050
A6CR10	1901-0050	3		DIODE-SWITCHING 80V 200MA 2NS DO-35	28480	1901-0050
A6CR11	1901-0050	3		DIODE-SWITCHING 80V 200MA 2NS DO-35	28480	1901-0050
A6CR12	1901-0050	3		DIODE-SWITCHING 80V 200MA 2NS DO-35	28480	1901-0050
A6F1	2110-0540	0	1	FUSE 2A 125V NTD .281X.093	75915	275002
A6J1	1251-5370	1	1	CONNECTOR 11-PIN M POST TYPE	28480	1251-5370
A6L1	9140-1788	6	1	CHOKE-WIDE BAND ZMAX=680 OHMS 180 MHZ	02114	UK200 20/48
A6L2	9140-0320	4	1	INDUCTOR 75UH 8% .7DX.6LG	28480	9140-0320
A6Q1	1853-0363	8	2	TRANSISTOR PNP SI PD=50W FT=20MHZ	03508	X45H281
A6Q2	1854-0477	7	3	TRANSISTOR NPN 2N2222A SI TO-18 PD=500MW	04713	2N2222A
A6Q3	1853-0036	2	3	TRANSISTOR PNP SI PD=310MW FT=250MHZ	28480	1853-0036
A6Q4	1853-0036	2		TRANSISTOR PNP SI PD=310MW FT=250MHZ	28480	1853-0036
A6Q5	1853-0363	8		TRANSISTOR PNP SI PD=50W FT=20MHZ	03508	X45H281
A6Q6	1854-0477	7		TRANSISTOR NPN 2N2222A SI TO-18 PD=500MW	04713	2N2222A
A6Q7	1854-0477	7		TRANSISTOR NPN 2N2222A SI TO-18 PD=500MW	04713	2N2222A
A6Q8	1853-0036	2		TRANSISTOR PNP SI PD=310MW FT=250MHZ	28480	1853-0036
A6R1	0757-0398	4	1	RESISTOR 75 1% .125W F TC=0+-100	24546	C4-1/8-T0-75R0-F
A6R2	0698-3438	3	1	RESISTOR 147 1% .125W F TC=0+-100	24546	C4-1/8-T0-147R-F
A6R3	0757-0276	7	1	RESISTOR 61.9 1% .125W F TC=0+-100	24546	C4-1/8-T0-6192-F
A6R4	0757-0280	3	2	RESISTOR 1K 1% .125W F TC=0+-100	24546	C4-1/8-T0-1001-F
A6R5	0312-0021	8	1	RESISTOR .47 5% 3W PW TC=0+-90	91637	CW2B1-3-T2-47/100-J
A6R6	0757-0442	9	6	RESISTOR 10K 1% .125W F TC=0+-100	24546	C4-1/8-T0-1002-F
A6R7	0757-0401	0	1	RESISTOR 100 1% .125W F TC=0+-100	24546	C4-1/8-T0-101-F
A6R8	0698-8022	9	1	RESISTOR 6.81 1% .125W F TC=0+-100	28480	0698-8022
A6R9	0757-0274	5	1	RESISTOR 1.21K 1% .125W F TC=0+-100	24546	C4-1/8-T0-1211-F
A6R10	0757-0290	5	1	RESISTOR 6.19K 1% .125W F TC=0+-100	19701	MF4C1/8-T0-6191-F
A6R11	0757-1093	6	1	RESISTOR 3K 1% .125W F TC=0+-100	24546	C4-1/8-T0-3001-F
A6R12	0698-0032	7	1	RESISTOR 464 1% .125W F TC=0+-100	24546	C4-1/8-T0-4640-F
A6R13	0698-3155	1	1	RESISTOR 4.64K 1% .125W F TC=0+-100	24546	C4-1/8-T0-4641-F
A6R14	0757-0293	6	3	RESISTOR 7K 1% .125W F TC=0+-100	24546	C4-1/8-T0-2001-F
A6R15	0757-0442	9		RESISTOR 10K 1% .125W F TC=0+-100	24546	C4-1/8-T0-1002-F
A6R16	0757-0442	9		RESISTOR 10K 1% .125W F TC=0+-100	24546	C4-1/8-T0-1002-F
A6R17	0757-0281	6		RESISTOR 2K 1% .125W F TC=0+-100	24546	C4-1/8-T0-2001-F
A6R18	0811-1827	2	1	RESISTOR .1 10% 3W PW TC=0+-90	28480	0811-1827
A6R19	2100-2497	9	2	RESISTOR-TRMR 2K 10% C TOP-ADJ 1-TRN	73138	82PR2K
A6R20	2100-2497	9		RESISTOR-TRMR 2K 10% C TOP-ADJ 1-TRN	73138	82PR2K
A6R21	0757-0419	0	1	RESISTOR 681 1% .125W F TC=0+-100	24546	C4-1/8-T0-681R-F
A6R22	0757-0465	6	1	RESISTOR 100K 1% .125W F TC=0+-100	24546	C4-1/8-T0-1003-F
A6R23	0757-0280	3		RESISTOR 1K 1% .125W F TC=0+-100	24546	C4-1/8-T0-1001-F
A6R24	0757-0441	8	1	RESISTOR 8.25K 1% .125W F TC=0+-100	24546	C4-1/8-T0-8251-F
A6R25	0757-0199	3	2	RESISTOR 21.5K 1% .125W F TC=0+-100	24546	C4-1/8-T0-2152-F
A6R26	0757-0442	9		RESISTOR 10K 1% .125W F TC=0+-100	24546	C4-1/8-T0-1002-F
A6R27	0757-0442	9		RESISTOR 10K 1% .125W F TC=0+-100	24546	C4-1/8-T0-1002-F
A6R28	0757-0472	5	1	RESISTOR 200K 1% .125W F TC=0+-100	24546	C4-1/8-T0-2003-F
A6R29	0757-0199	3		RESISTOR 21.5K 1% .125W F TC=0+-100	24546	C4-1/8-T0-2152-F
A6R30	0698-3160	8	1	RESISTOR 31.6K 1% .125W F TC=0+-100	24546	C4-1/8-T0-3162-F

See introduction to this section for ordering information
*Indicates factory selected value

Table 7-5. 5315A-A6 Assembly Replaceable Parts (Continued)

Reference Designation	HP Part Number	C D	Qty	Description	Mfr Code	Mfr Part Number
A6R31	0698-3156	2	1	RESISTOR 14.7K 1% .125W F TC=0+-100	24546	C4-178-T0-1470-F
A6R32	0257-0442	2		RESISTOR 10K 1% .125W F TC=0+-100	24546	C4-178-T0-1000-F
A6R33	0257-0462	3	1	RESISTOR 25K 1% .125W F TC=0+-100	24546	C4-178-T0-2500-F
A6R34	0257-0442	4	1	RESISTOR 16.2K 1% .125W F TC=0+-100	24546	C4-178-T0-1620-F
A6R35	0257-0283	6		RESISTOR 2K 1% .125W F TC=0+-100	24546	C4-178-T0-2000-F
A6R36	0257-0402	6	1	RESISTOR 200 1% .125W F TC=0+-100	24546	C4-178-T0-200-F
A6R37	0811-3112	7	1	RESISTOR 12 1/2 2W PW TC=0+-20	28480	0811-3112
A6RT1	0837-0159	5	1	THERMISTOR 33K-0HM TC=+1.7%/C-DIG	01295	T8-178-333K
A6S1	3101-2351	7	3	SWITCH-PB SPST-NO MOM 1A 120VAC BLK-BTN	28480	3101-2351
A6S2	3101-2351	7		SWITCH-PB SPST-NO MOM 1A 120VAC BLK-BTN	28480	3101-2351
A6S3	3101-2351	7		SWITCH-PB SPST-NO MOM 1A 120VAC BLK-BTN	28480	3101-2351
A6TP1	1251-0600	0	3	CONNECTOR-SGL CONT PIN 1.14-MM-BSC-SZ SQ	28480	1251-0600
A6TP2	1251-0600	0		CONNECTOR-SGL CONT PIN 1.14-MM-BSC-SZ SQ	28480	1251-0600
A6TP3	1251-0600	0		CONNECTOR-SGL CONT PIN 1.14-MM-BSC-SZ SQ	28480	1251-0600
A6TP4	1251-0600	0		CONNECTOR-SGL CONT PIN 1.14-MM-BSC-SZ SQ	28480	1251-0600
A6TP5	1251-0600	0		CONNECTOR-SGL CONT PIN 1.14-MM-BSC-SZ SQ	28480	1251-0600
A6TP6	1251-0600	0		CONNECTOR-SGL CONT PIN 1.14-MM-BSC-SZ SQ	28480	1251-0600
A6TP7	1251-0600	0		CONNECTOR-SGL CONT PIN 1.14-MM-BSC-SZ SQ	28480	1251-0600
A6TP8	1251-0600	0		CONNECTOR-SGL CONT PIN 1.14-MM-BSC-SZ SQ	28480	1251-0600
A6U1	1826-0450	7	1	IC V RELTR 14-DIP-P	01295	TL497DN
A6U2	1826-0424	5	1	IC OP AMP GP DUAL 14-DIP-P PKG	04713	MC3405P
A6U3	1826-0467	6	1	V RFT PRON 8 DIP-P	04713	MC1483P1
A6U4	1820-1600	9	1	IC SCHMITT-TRIG CMOS NAND QUAD 2-IMP	01928	CD4073NE
A6U5	1826-0412	1	1	IC COMPARATOR PRON DUAL 8-DIP-P PKG	27014	LM393N
A6 MISCELLANEOUS PARTS						
	0360-0295	9	2	TERMINAL-STUD FKD-TUR SWGFRM-MTG	28480	0360-0295
5315A CHASSIS PARTS						
BT1	1420-0253	8	1	BATTERY 6 V 5A-HR PB-ACID QDISC	0139E	0800-0011
MP22	05315-00005	1	1	CLAMP-BATTERY	28480	05315-00005
MP23	05315-00006	2	1	DECK-BATTERY	28480	05315-00006
MP24	0510-0585	9	6	RETAINER-PUSH ON	28480	0510-0585
MP25	0531353-00014	2	1	CLIP-GROUNDING	28480	05315-00014
MISCELLANEOUS PARTS						
W2	05315-60102	5	1	CABLE ASSEMBLY-LEAD (RED)	28480	05315-60102
W3	05315-60103	6	1	CABLE ASSEMBLY-LEAD (BLACK)	28480	05315-60103
W4	05315-60101	4	1	CABLE ASSEMBLY-BATTERY	28480	05315-60101

See introduction to this section for ordering information
*Indicates factory selected value